



Overview of Cisco IAD2430 Series IADs

This chapter provides a brief description of Cisco IAD2430 series integrated access devices and contains the following sections:

- [Overview, page 1-1](#)
- [Cisco IAD2430 Series Deployment, page 1-6](#)
- [Interfaces and Service Capabilities, page 1-7](#)
- [Physical Description and LEDs, page 1-9](#)
- [Specifications, page 1-11](#)
- [Software Elements, page 1-12](#)

Overview

The Cisco IAD2430 series integrated access devices (IADs) aggregate multiple channels of data and voice or fax user-side traffic for transport over single or multiple wide-area network (WAN) uplinks. Voice or fax traffic is transported by Voice over Internet Protocol (VoIP) or by Voice over Asynchronous Transfer Mode (VoATM). All platforms support Media Gateway Control Protocol (MGCP), the signaling protocol H.323, and Session Initiation Protocol (SIP).

Cisco IAD2430 series IADs support the following interfaces:

- 10/100BASE-T LAN connection
- T1/E1 port connections
- RJ-21 analog voice interface
- WIC/VIC options
- External/Internal compact flash

Cisco IAD2430 series IADs can be housed in a rack, mounted on a wall, or set on a benchtop surface.



This unit is intended for installation in restricted access areas. A restricted access area can be accessed only through the use of a special tool, lock and key, or other means by security. Statement 1017

Figure 1-1 Cisco IAD2430 Series IADs Front Panel

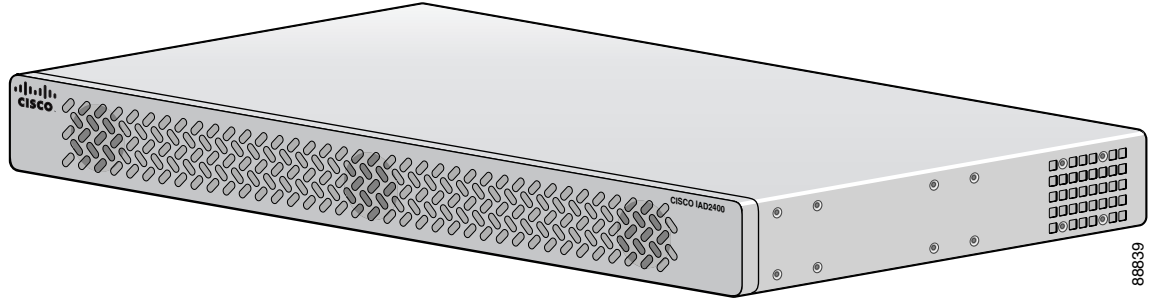

Figure 1-2 through Figure 1-6 show the basic types of Cisco IAD2430 series chassis as seen from the cabling side.

Cisco IAD2430-24FXS

The Cisco IAD2430-24FXS provides 24 analog foreign exchange station (FXS) ports with two 10/100BASE-T ports. The chassis has the following interfaces:

- RJ-21 analog voice interface
- Two 10/100BASE-T ports
- External compact flash memory
- AC and DC power inputs

Figure 1-2 Cisco IAD2430-24FXS Chassis

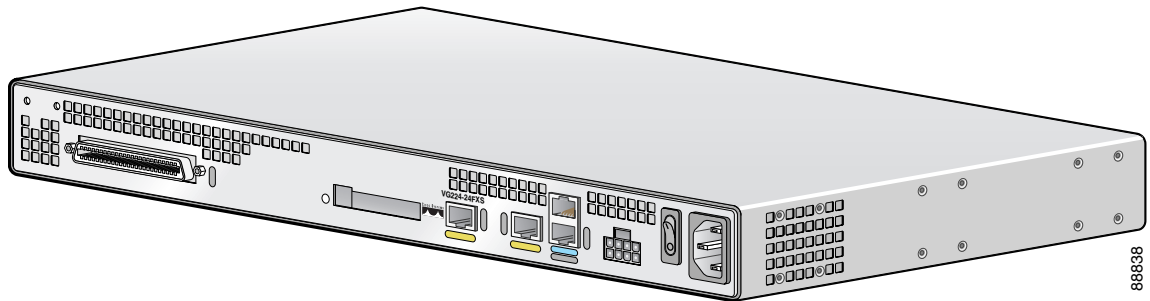

Cisco IAD2431-8FXS

The Cisco IAD2431-8FXS provides eight analog FXS ports, two 10/100BASE-T ports, and one T1/E1 WAN port. The chassis has the following interfaces:

- RJ-21 analog voice interface
- One T1/E1 port
- One 10/100BASE-T port
- One WIC/VIC slot
- External compact flash memory
- AC and DC power inputs

Figure 1-3 Cisco IAD2431-8FXS Chassis

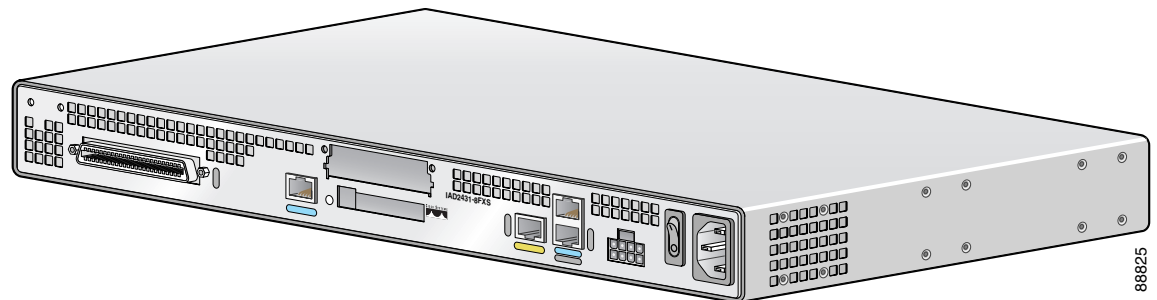

Cisco IAD2431-16FXS

The Cisco IAD2431-16FXS provides sixteen analog FXS ports with two 10/100BASE-T ports and two T1/E1 WAN ports. The chassis has the following interfaces:

- RJ-21 analog voice interface
- One T1/E1 port
- Two 10/100BASE-T ports
- One WIC/VIC slot
- External compact flash memory
- AC and DC power inputs

Figure 1-4 Cisco IAD2431 -16FXS

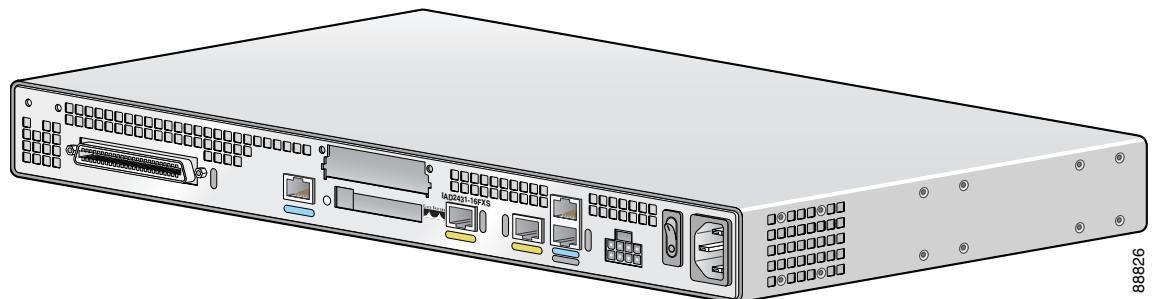

Cisco IAD2431-1T1E1

The Cisco IAD2431-1T1E1 provides one T1/E1 connection to a PBX, one T1/E1 WAN port, and two 10/100BASE-T ports. The chassis has the following interfaces:

- Two T1/E1 ports
- Two 10/100BASE-T ports
- One WIC/VIC slot
- External compact flash memory
- AC and DC power inputs

Figure 1-5 Cisco IAD2431-1T1E1

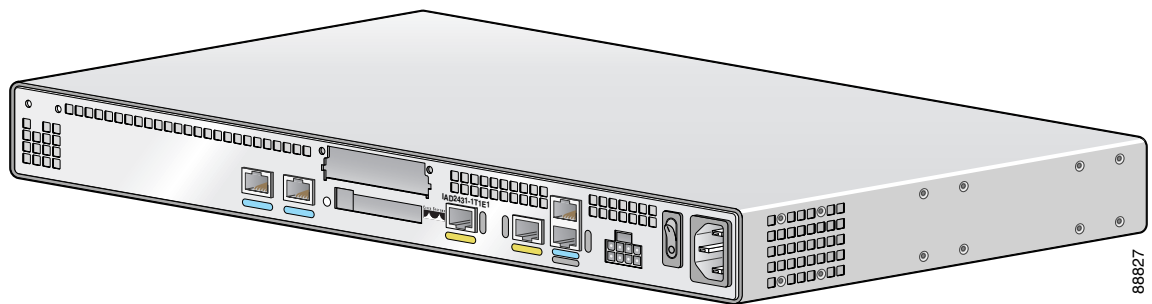

Cisco IAD2432-24FXS

The Cisco IAD2432-24FXS provides 24 analog FXS ports, two 10/100BASE-T ports, and two T1/E1 WAN ports. The chassis has the following interfaces:

- RJ-21 analog voice interface
- Two T1/E1 ports
- Two 10/100BASE-T ports
- One WIC/VIC slot
- External compact flash memory
- AC and DC power inputs

Figure 1-6 Cisco IAD2432-24FXS

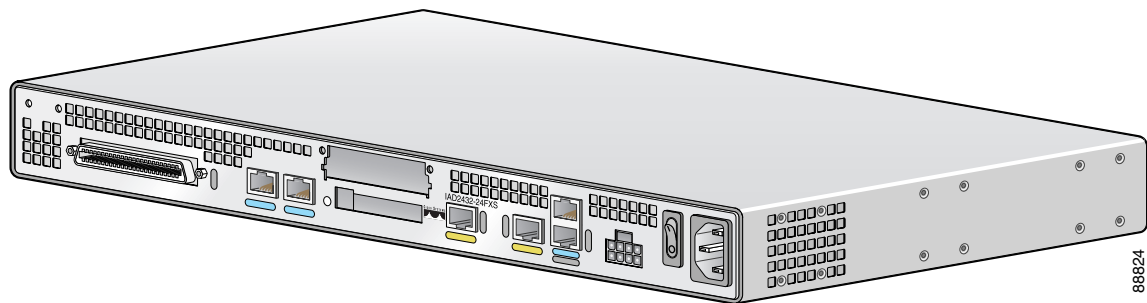

Product Serial Number Location for the Cisco IAD2430 Series IADs

The serial number label for the Cisco IAD2430 Series IADs is located on the rear of the chassis, in the middle-left side. (See [Figure 1-14](#).)

Figure 1-7 Serial Number Locations

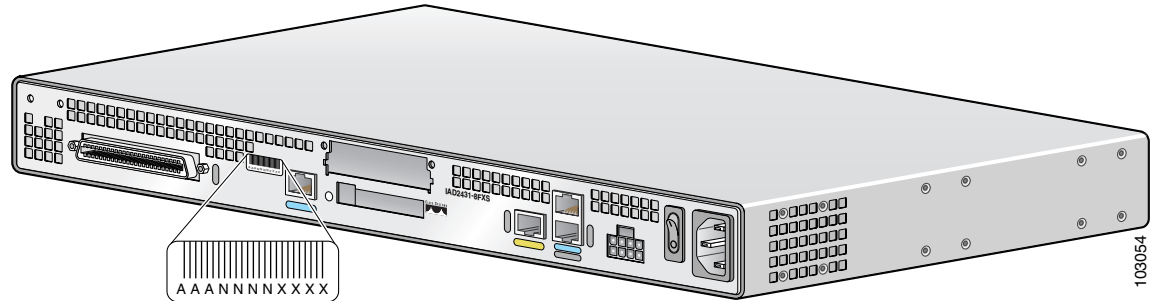

Note

The serial number for the Cisco IAD2430 Series IADs is 11 characters long.

Configuration Options

The following interface options are available in Cisco IAD2430 series IADs:

Table 1-1 Configuration Options

Cisco IAD2430 Series	RJ-21 ¹	T1/E1 ²	FE ³	WIC/VIC ⁴	CF ⁵
IAD2430-24FXS	yes	none	2	n/a	external
IAD2431-8FXS	yes	1	1	yes	external
IAD2431-16FXS	yes	1	2	yes	external
IAD2431-1T1E1	no	2	2	yes	external
IAD2432-24FXS	yes	2	2	yes	external

1. Analog voice interface
2. T1/E1 ports
3. 10/100BASE-T ports
4. WAN interface card (data); voice interface card (voice)
5. Compact flash

Cisco IAD2430 Series Deployment

Figure 1-8 through Figure 1-11 show some typical deployment scenarios for Cisco IAD2430 series integrated access devices.

Figure 1-8 Analog FXS User Interfaces with Metro Ethernet WAN Interface

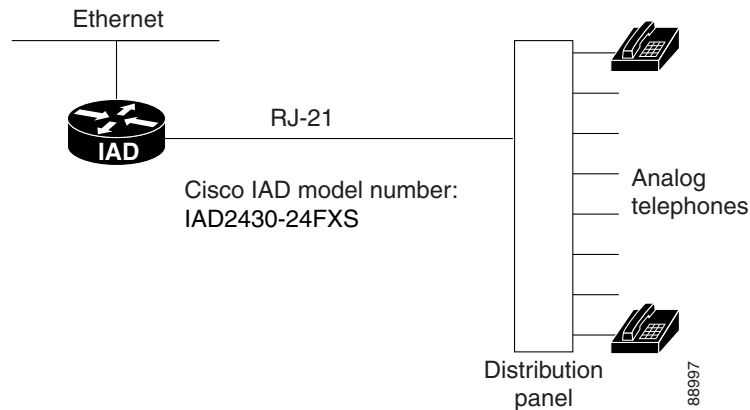

Figure 1-9 T1/E1 WAN Interface with Analog FXS User Interfaces

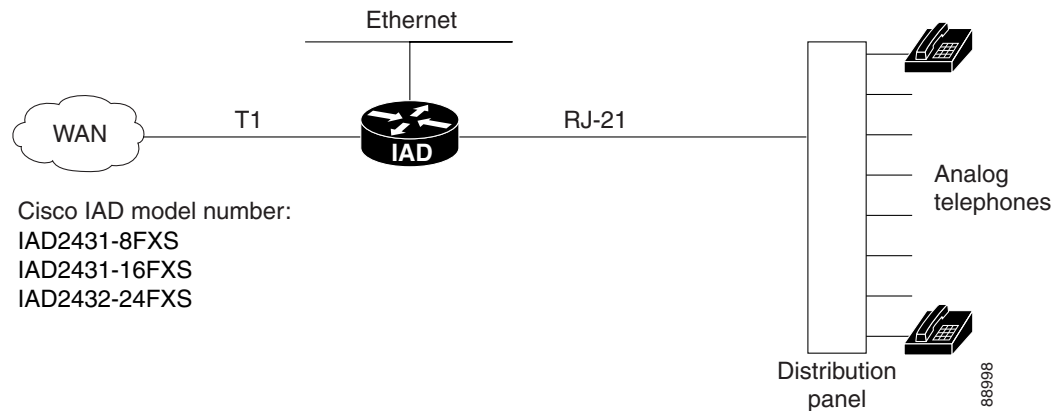
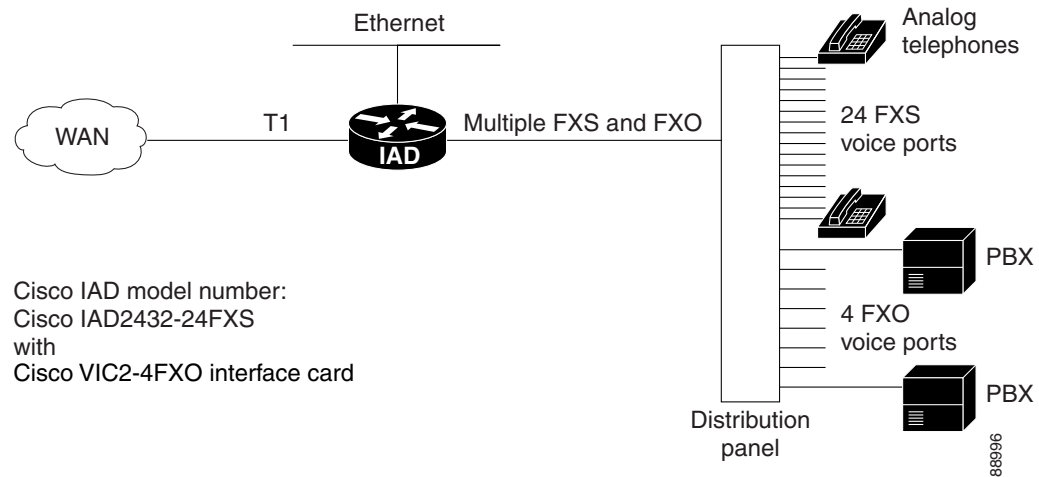
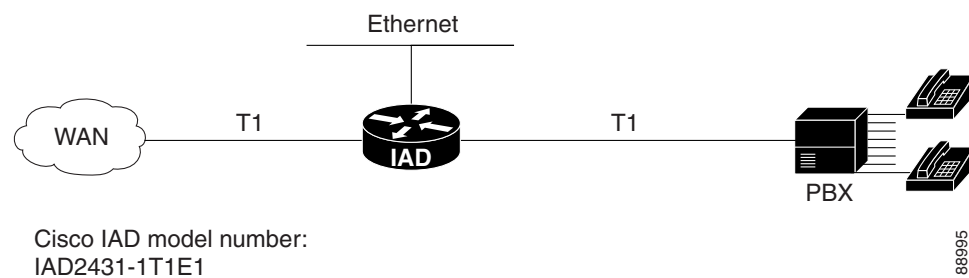

Figure 1-10 WAN Interface with Analog FXS and FXO User Interfaces**Figure 1-11 T1/E1 with T1/E1 Interface to PBX**

Interfaces and Service Capabilities

The various physical ports and the services supported by each port type are described in [Table 1-2](#).

- Two administrative ports—One console and one auxiliary.
- One or two 10/100BASE-T LAN ports.
- The Cisco IAD2431 and Cisco IAD2432 IADs for T1/E1 WAN interface are equipped with one or two T1/E1 WAN ports.
- Cisco IAD2430 series IADs for analog voice user interface are equipped with an RJ-21 port for connection to a distribution panel.
- Cisco IAD2432 IADs for digital voice user interface are equipped with a T1/E1 port for connection to a PBX.



Caution

All Cisco 2430 series IADs are customer premises equipment (CPE) only.

Table 1-2 Cisco IAD2430 Series Interfaces and Service Capabilities

Port	Interface Configurations	Interface To	Services Supported	Details
Console Port 0/0	EIA/TIA-232 asynchronous serial (DCE ¹)	ASCII terminal Personal computer	Local administrative access	RJ-45 physical interface
Auxiliary Port 0/1	EIA/TIA-232 asynchronous serial (DTE ²)	Modem	Remote administrative access Data backup	RJ-45 physical interface
Fast Ethernet Port 0/0, 0/1	10/100BASE-T (802.3)	LAN	Data	RJ-45 physical interface
RJ-21 8, 16, or 24 analog FXS voice ports Port 2/0 to 2/23	FXS (loop-start or ground-start)	Analog phone, fax, or modem Network side of key system Network side of analog PBX	Analog voice/fax or modem	Provides battery RJ-21 physical interface 8-port FXS, on premise only 16-port FXS, on premise only 24-port FXS, on premise only
T1/E1 trunk Port 0,1	Channelized T1/E1	WAN Carrier network	Service types: <ul style="list-style-type: none"> • ATM • Cisco HDLC³ • PPP³ Transport types: <ul style="list-style-type: none"> • TDM⁴ trunk • Leased lines 	Built-in CSU/DSU ⁵ T1.403-compliant RJ-48C/CA81A physical interface Supports as many as 24 DS0s
WIC/VIC slot S0 (serial)	HDLC-based data	WAN Carrier network User equipment	Cisco HDLC PPP ⁶ VoIP over PPP	Physical interfaces: <ul style="list-style-type: none"> • EIA/TIA-232 • EIA/TIA-530/530A • EIA/TIA-449 • V.35 • X.21
CF ⁷ Slot 0			Flash memory	Compact flash card

1. DCE = data communications equipment
2. DTE = data terminal equipment
3. HDLC = High-Level Data Link Control
4. TDM = time-division multiplexing
5. CSU/DSU = channel service unit/data service unit
6. PPP = Point-to-Point Protocol
7. CF = compact flash memory

Physical Description and LEDs

All interface slots and LEDs are on the rear of the chassis.

Figure 1-12 Cisco IAD2430 Series IAD

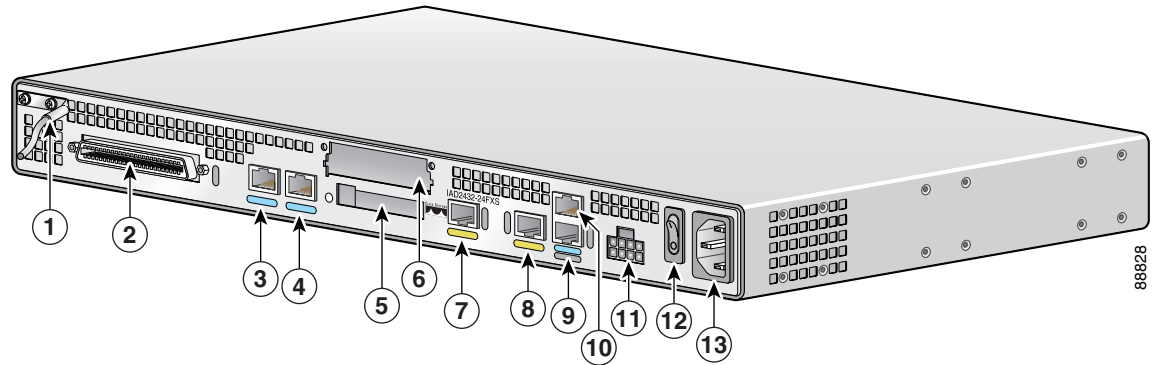

1	Chassis ground connection	6	WIC/VIC slot	11	DC power input ¹
2	RJ-21 connector	7	10/100BASE-T port 1	12	On/off switch
3	T1/E1 port 1	8	10/100BASE-T port 0	13	AC power input
4	T1/E1 port 0	9	AUX port		
5	Compact flash slot	10	Console port		

1. This is not a redundant failover power supply connection. You must use either DC or AC.

Figure 1-13 Cisco IAD2400 Series LEDs

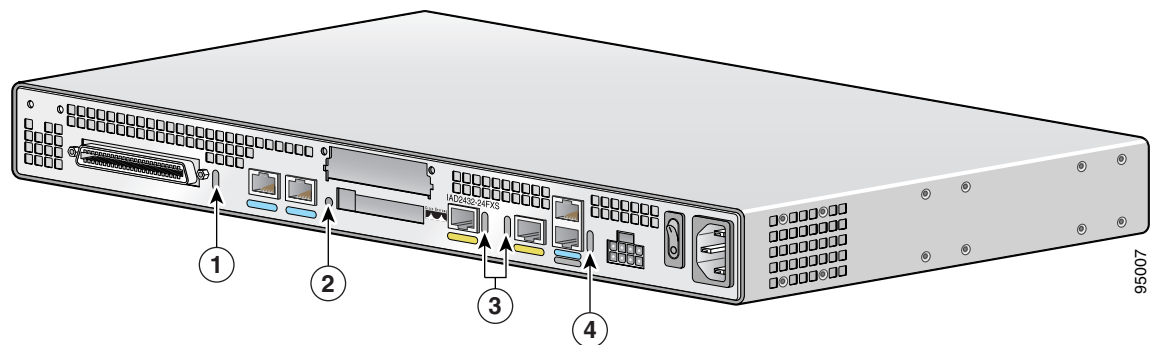

Table 1-3 Cisco 2430 Series IAD LEDs (Cisco 2432-24FXS shown)

No	LED/Color	Description
1	ACT—green	Green indicates activity; when any of the 24 voice ports is active in a call (off hook) or one of the analog ports is in use
	Status—green	Green when accessing IAD
2	CF (Slot 0)—green	Green when accessing read or write function

Table 1-3 Cisco 2430 Series IAD LEDs (Cisco 2432-24FXS shown)

No	LED/Color	Description
3	Link—green	Indicates link activity
	100—green	100BASE-T active
	FDX—green	Green when full duplex active, off when in half-duplex mode
4	ACT—green	Blinking green during packet transfer and interrupts
	SYS—green	Blinking green for power on and self-test, solid green thereafter
	PWR—green	Solid green when system has power

Product Serial Number Location for Cisco IAD2430 Series IADs

The serial number label for the Cisco IAD2430 Series IADs is located on the rear of the chassis, in the middle-left side. (See [Figure 1-14](#).)

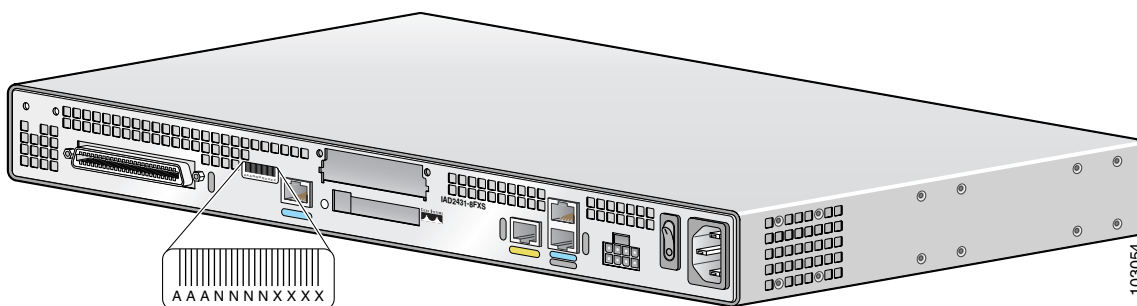
Figure 1-14 Serial Number Locations**Note**

The serial number for Cisco IAD2430 Series IADs is 11 characters long

Chassis Grounding

Chassis grounding is provided through the power cable, which uses a standard grounding plug. The chassis is also equipped with two multi 4 x 0.7 screw terminals for chassis grounding. The accessory kit contains a crimp-type ground lug that attaches to the two screw terminals. For more information, refer to the “[Installing the Ground Connection](#)” section on [page 3-11](#).

Port Numbering Conventions

Port numbering conventions for Cisco IAD2430 series IAD are as follows:

- An external compact flash card is numbered CF 0.
- 10/100BASE-T ports are numbered 10/100BASE-T 0/0 and 10/100BASE-T 0/1 from right to left.
- T1/E1 ports are numbered T1 or E1 1/0 and T1 or E1 1/1 from right to left.

- The slot for WICs and VICs is numbered slot 0. WIC and VIC interfaces are numbered by interface with this slot number and an interface number, beginning with 0 and running from right to left.
- FXS voice port numbering begins at 2/0 and extends to 2/7, 2/15, or 2/23, depending on the number of voice ports.

Specifications

Table 1-4 Cisco IAD2430 Series IAD Technical Specifications

Characteristic	Value
Dimensions	1.75H x 17.5W x 13.5D in. (44.4 x 444.5 x 342.9 mm)
Weight	11 lb (4.106 kg) max
Input power	100 to 240 VAC, 1 A (max), 50 to 60 Hz, 70 W (max)
Maximum power surge	
Input power (DC 12-volt battery) by chassis	<ul style="list-style-type: none"> • Cisco IAD2430-24FXS—60 W (204.7 BTU/h) • Cisco IAD2431-8FXS—50 W (170.6 BTU/h) • Cisco IAD2431-16FXS—60 W (204.7 BTU/h) • Cisco IAD2432-24FXS—70 W (238.8 BTU/h) • Cisco IAD2431-1T1E1—35 W (119.4 BTU/h)
	 <p>Caution Do not try to use AC and DC power at the same time. If you do, the unit stops operating and you have to reboot using a single power source.</p>
MTBF	<ul style="list-style-type: none"> • Cisco IAD2430-24FXS—195,671 hours • Cisco IAD2431-8FXS—121,434 hours • Cisco IAD2431-16FXS—112,421 hours • Cisco IAD2432-24FXS—103,628 hours • Cisco IAD2431-1T1E1—126,118 hours
Operating environment	32 to 122°F (0 to 50°C)
Nonoperating temperature	–40 to 185°F (–40 to 85°C)
Operating humidity	5 to 95%, noncondensing
Noise level	55 dB @ 3 ft
Agency approvals	Refer to the <i>Cisco IAD2400 Series Regulatory Compliance and Safety Information</i> document that accompanied your device for agency approvals.



Warning

Ultimate disposal of this product should be handled according to all national laws and regulations.
Statement 1040

Software Elements

The operating system for Cisco IAD2430 series IADs is the Cisco IOS software that resides in flash memory.

Configuration Connections

You can use an ASCII terminal or a PC to configure a Cisco IAD2430 series IAD. The configuration can be performed in several ways:

- Locally, with a direct connection through the console port
- Remotely, with a connection through the auxiliary port and a modem
- Through Telnet and TFTP

Configuration Methods

Automated Configuration

If your Cisco IAD2430 series IAD was ordered with the Simple Network-Enabled Auto-Provision (SNAP) option, no on-site configuration is required. When the Cisco IAD is powered on and connected to the WAN, the SNAP application downloads the applicable configuration files automatically. For additional information about SNAP, refer to the *Simple Network-Enabled Auto-Provisioning for Cisco 2420 Series IAD* feature module at the following URL:

<http://www.cisco.com/univercd/cc/td/doc/product/software/ios122/122newft/122t/122t8/ftapiad8.htm>

Manual Configuration

When a Cisco IAD2430 series IAD is first installed, use the procedure in [Chapter 4, “Powering On Cisco IAD2430 Series IADs,”](#) for the initial configuration. This sets the basic communication parameters. After the Cisco IAD is operating and able to communicate, use the procedures in the *Cisco IAD2430 Series Software Configuration Guide* to configure the specific services and functions, or to make changes to the existing configuration.

There are multiple methods for configuring a Cisco IAD2430 series IAD:

- System configuration dialog
- Configuration mode—Cisco IOS software command-line interface (CLI)
- Setup command facility—Remote configuration through a LAN or WAN
- SNMP-based application—CiscoView or HP OpenView
- HTTP-based configuration server—Provides access to the CLI from a web browser