

FortiGate-60M LED Indicators

LED	State	Description
Power	Green	The FortiGate unit is powered on.
	Off	The FortiGate unit is powered off.
Status	Green	The FortiGate unit is starting up.
	Off	The FortiGate unit is running normally.
Link (Internal DMZ WAN1 WAN2)	Green	The correct cable is in use and the connected equipment has power.
	Flashing Green	Network activity at this interface.
	Off	No link established.
100 (Internal DMZ WAN1 WAN2)	Green	The interface is connected at 100 Mbps.

FORTINET FortiGate-60M

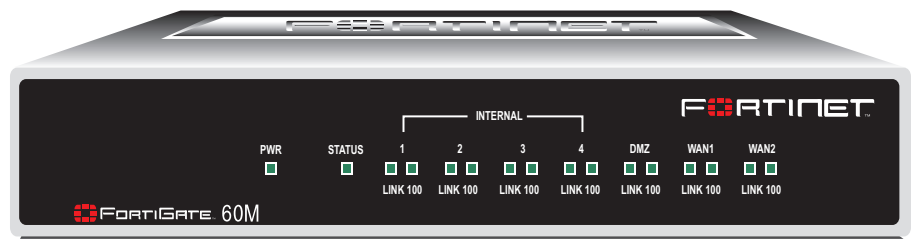

QuickStart Guide

© Copyright 2004 Fortinet Incorporated. All rights reserved.

Trademarks

Products mentioned in this document are trademarks or registered trademarks of their respective holders.

Regulatory Compliance

FCC Class A Part 15 CSA/CUS

03 November 2004

For technical support please visit <http://www.fortinet.com>.

01-28005-0110-20041103

1 Checking the package contents

Check that the package contents are complete.

Connector	Type	Speed	Protocol	Description
Internal	RJ-45	10/100Base-T	Ethernet	4-port switch connection to up to four devices or the internal network.
WAN1 and 2	RJ-45	10/100Base_T	Ethernet	Redundant connections to the Internet.
DMZ	RJ-45	10/100Base-T	Ethernet	Optional connection to a DMZ network or to other FortiGate -60M units for high availability (HA).
CONSOLE	RJ-45	9600 bps	RS-232 serial	Optional connection to the management computer. Provides access to the command line interface (CLI).
USB	USB	—	USB	Optional connection to a modem for standalone or backup operation.
Phone cable	RJ-11	—	—	Phone line for internal modem.

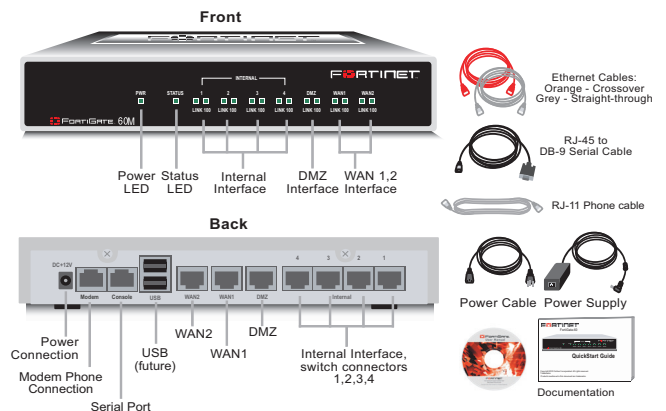

2 Connecting the FortiGate-60M

Connect the FortiGate-60M unit to a power outlet and to the internal and external networks.

- Place the unit on a stable surface. It requires 1.5 inches (3.75 cm) clearance above and on each side to allow for cooling.
- Make sure the power switch on the back of the unit is turned off before connecting the power and network cables.
- The Status light flashes while the unit is starting up and turns off when the system is up and running.

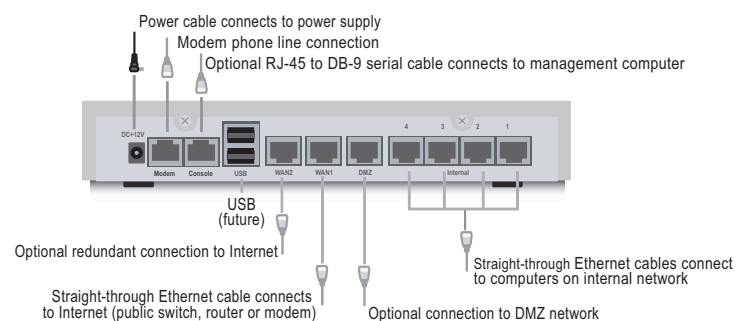

3 Planning the configuration

Before configuring the FortiGate-60M, you need to plan how to integrate the unit into your network. You can select NAT/Route mode (the default) or Transparent mode. In NAT/Route mode you can also use the default settings to quickly configure the unit on your network.

Quick configuration using the default settings

You can quickly set up your FortiGate unit for a home or small office using the web-based manager and the default settings in NAT/Route mode.

All you need to do is set your network computers to use DHCP, access the web-based manager, and configure the required settings for the WAN1 interface. You can also configure DNS and a default route if needed. The FortiGate unit automatically assigns IP addresses to up to 100 computers in the internal network.

- Connect the FortiGate unit to the network.
- Set the all the network computers to use DHCP to automatically obtain an IP address.
The FortiGate internal interface acts as a DHCP server for the internal network and assigns IP addresses to all computers in the range 192.168.1.110 –192.168.1.210.
- From the management computer browse to <https://192.168.1.99>.
The FortiGate web-based manager appears.
- Go to **System > Network > Interface** and select Edit for the WAN1 interface.
- Select one of the following Addressing modes
 - Manual: enter a static IP address and netmask, select OK, and go to step 6
 - DHCP: to get an IP address from the ISP select DHCP and go to step 9
 - PPPoE: to get an IP address from the ISP select PPPoE and go to step 9

- Go to **System > Network > DNS**.
- Select one of the following DNS settings
 - Obtain DNS server address automatically: select to get the DNS addresses from the ISP, select Apply
 - Use the following DNS server addresses: select and enter the DNS server addresses given to you by the ISP, select Apply
- Go to **Router > Static**, select Create New, enter the default gateway address and select OK.
Network configuration is complete. Proceed to part 7 of this *Quick Start Guide*.
- Select Retrieve default gateway from server and Override internal DNS options if your ISP supports them, select OK, and proceed to part 7 of this *Quick Start Guide*.
Go to step 6 if you are not selecting these options.

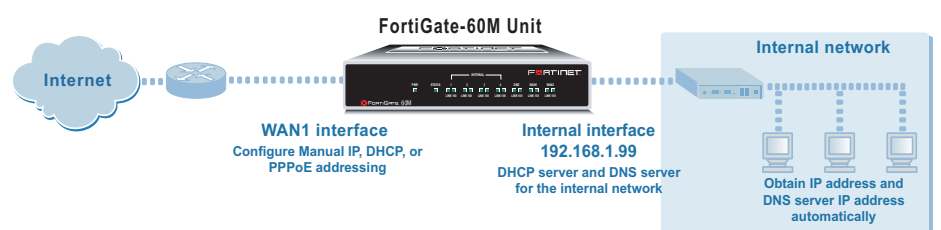

NAT/Route mode

In NAT/Route mode, the FortiGate-60M is visible to the networks that it is connected to. All of its interfaces are on different subnets. You must configure the internal and WAN1 interfaces with IP addresses. Optionally, you can also configure the WAN2 and DMZ interfaces.

You would typically use NAT/Route mode when the FortiGate-60M is deployed as a gateway between private and public networks. In its default NAT/Route mode configuration, the unit functions as a firewall. Firewall policies control communications through the FortiGate-60M unit.

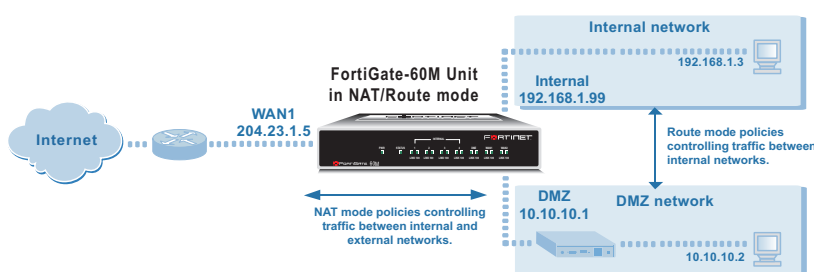

In NAT/Route mode, firewall policies can operate in NAT mode or in Route mode. In NAT mode, the FortiGate-60M performs network address translation before IP packets are sent to the destination network. In Route mode, no translation takes place. By default, the unit has a single NAT mode policy that allows users on the internal network to securely access and download content from the Internet. No other traffic is possible until you have configured more policies.

Transparent mode

In Transparent mode, the FortiGate-60M is invisible to the network. All of its interfaces are on the same subnet. You only have to configure a management IP address so that you can make configuration changes.

You would typically use the FortiGate-60M in Transparent mode on a private network behind an existing firewall or behind a router. In its default Transparent mode configuration, the unit functions as a firewall. By default, the unit has a single firewall policy that allows users on the internal network segment to connect to the WAN1 network segment. No other traffic is possible until you have configured more policies.

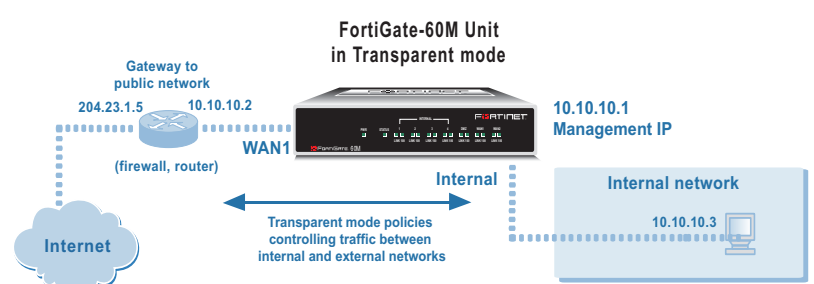

You can connect up to four network segments to the FortiGate-60M unit to control traffic between these network segments.

Refer to the Documentation CD-ROM for information on how to control traffic, and how to configure HA, antivirus protection, Web content filtering, Spam filtering, intrusion prevention (IPS), and virtual private networking (VPN).

4 Choosing a configuration tool

Choose among two different tools to configure the FortiGate-60M.

Web-based manager and Setup Wizard

Using the Setup Wizard you can add basic settings by stepping through the wizard pages and filling in the information required.

The FortiGate web-based manager is an easy to use management tool. Use it to configure the administrator password, interface addresses, the default gateway address, and the DNS server addresses.

Requirements: An Ethernet connection between the FortiGate-60M and a management computer running Internet Explorer version 6.0 or higher.

Command Line Interface (CLI)

The CLI is a full-featured management tool.

Use it to configure the administrator password, the interface addresses, the default gateway address, and the DNS server addresses. To configure advanced settings, see the Documentation CD-ROM.

Requirements: An RJ-45-serial connection between the FortiGate-60M and management computer and a terminal emulation application (HyperTerminal for Windows) on the management computer.

5 Collecting information

Use these tables to record your FortiGate-60M configuration settings.

NAT/Route mode

Internal Interface:	IP: _____
	Netmask: _____
WAN1 Interface:	IP: _____
	Netmask: _____
WAN2 Interface:	IP: _____
	Netmask: _____
DMZ	IP: _____
	Netmask: _____

The internal interface IP address and netmask must be valid for the internal network.

Transparent mode

Management IP:	IP: _____
	Netmask: _____

The management IP address and netmask must be valid for the network from which you will manage the FortiGate-60M.

General settings

Administrator password:	_____
Network Settings:	Default Gateway: _____
	Primary DNS Server: _____
	Secondary DNS Server: _____

A default gateway is required for the FortiGate unit to route connections to the Internet.

Factory default settings

NAT/Route mode		Transparent mode	
Internal interface	192.168.1.99	Management IP	10.10.10.1
WAN1 interface	192.168.100.99	Administrative account settings	
WAN2 interface	192.168.101.99	User name	admin
DMZ interface	10.10.10.1	Password	(none)
DHCP server on Internal interface	192.168.1.110 – 192.168.1.210		

6 Configuring the FortiGate-60M

1. Connect the FortiGate-60M internal interface to a management computer ethernet interface. You can connect the management computer directly to the FortiGate-60M internal interface 4-port switch.
2. Configure the management computer to be on the same subnet as the internal interface of the FortiGate-60M. To do this, change the IP address of the management computer to 192.168.1.2 and the netmask to 255.255.255.0.
3. To access the FortiGate web-based manager, start Internet Explorer and browse to https://192.168.1.99 (remember to include the "s" in https://).
4. Type admin in the Name field and select Login.

Web-based manager and Setup Wizard

NAT/Route mode

To configure the FortiGate-60M using the Setup Wizard, select the Easy Setup Wizard button and follow the prompts.

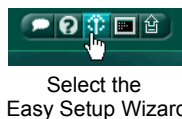

To change the administrator password

1. Go to **System > Admin > Administrators**.
2. Select Change Password for the admin administrator and enter a new password.

To configure interfaces

1. Go to **System > Network > Interface**.
2. Select the edit icon for each interface to configure.
3. Select one of the following Addressing modes (see the online help for information):
 - Manual: enter a static IP address and netmask, select OK
 - DHCP: select DHCP and any required settings
 - PPPoE: select PPPoE and enter a username and password and any other required settings

To configure the Primary and Secondary DNS server IP addresses

1. Go to **System > Network > DNS**, enter the Primary and Secondary DNS IP addresses that you recorded above and select Apply.

To configure a Default Gateway

1. Go to **Router > Static** and select Edit icon for the static route.
2. Set Gateway to the Default Gateway IP address recorded above and select OK.

Note: If you change the internal interface IP address (NAT/Route mode) or management IP address (Transparent mode), you must use this address to reconnect to the web-based manager and Setup Wizard. You might also have to change the IP address of the management computer to be on the same subnet as the new IP address.

Transparent mode

To switch from NAT/route mode to transparent mode

1. Go to **System > Status**, select Change beside Operation Mode, and select OK.
2. Change the IP address of the management computer to 10.10.10.2 and use Internet Explorer to browse to https://10.10.10.1.

To configure the FortiGate-60M using the Setup Wizard, select the Easy Setup Wizard button and follow the prompts.

To change the administrator password

1. Go to **System > Admin > Administrators**.
2. Select Change Password for the admin administrator and enter a new password.

To configure the management interface

1. Go to **System > Network > Management**.
2. Enter the Management IP address and netmask that you recorded above.
3. Select administrative access options if required and select OK.

To configure the Primary and Secondary DNS server IP addresses

1. Go to **System > Network > DNS**, enter the Primary and Secondary DNS IP addresses that you recorded above and select Apply.

To configure a Default Gateway

1. Go to **System > Network > Management**.
2. Set Default Gateway to the Default Gateway IP address that you recorded above and select OK.

Using the Command Line Interface

1. Use the serial cable to connect the FortiGate Console port to the management computer serial port.
2. Start a terminal emulation program (HyperTerminal) on the management computer. Use these settings: Baud Rate (bps) 9600, Data bits 8, Parity None, Stop bits 1, and Flow Control None.
3. At the Login: prompt, type admin and press Enter twice (no password required).

NAT/Route mode

1. Configure the FortiGate-60M internal interface.

```
config system interface
  edit internal
    set mode static
    set ip <intf_ip> <netmask_ip>
  end
```
2. Repeat to configure each interface, for example, to configure the WAN1 interface.

```
config system interface
  edit wan1
  ...
```
3. Configure the primary and secondary DNS server IP addresses.

```
config system dns
  set primary <dns-server_ip>
  set secondary <dns-server_ip>
end
```
4. Configure the default gateway.

```
config router static
  edit 1
    set gateway <gateway_ip>
end
```

Transparent mode

1. Change from NAT/Route mode to Transparent mode.

```
config system global
  set opmode transparent
end
```
2. Wait a moment and then log in again at the prompt.
3. Configure the Management IP address.

```
config system manageip
  set ip <mng_ip> <netmask>
end
```

Configure the DNS server IP address.

```
config system dns
  set primary <dns-server_ip>
  set secondary <dns-server_ip>
end
```
4. Configure the default route.

```
config router static
  edit 1
    set gateway <gateway_ip>
end
```

7 Completing the configuration

Congratulations!

You have finished configuring the basic settings. Your network is now protected from Internet-based threats. To explore the full range of configuration options, see the online help or the Documentation CD-ROM.

Restarting the FortiGate-60M

Should you mistakenly change a network setting and cannot connect to the unit, reboot the unit and try again or to set the unit back to factory defaults and start over again.

- To restart the unit, go to **System > Maintenance > ShutDown** and select Reboot. CLI: execute reboot
- To reset the unit, go to **System > Maintenance > Shutdown** and select Reset to factory default. CLI: execute factoryreset