



User Guide for the SoundPoint® IP 650

SIP 2.2

October, 2007 Edition
1725-12648-001 Rev. B1
SIP 2.2



Trademark Information

Polycom®, the Polycom logo design, SoundPoint® IP, SoundStation®, SoundStation VTX 1000®, ViaVideo®, ViewStation®, and Vortex® are registered trademarks of Polycom, Inc. Conference Composer™, Global Management System™, ImageShare™, Instructor RPT™, iPower™, MGC™, PathNavigator™, People+Content™, PowerCam™, Pro-Motion™, QSX™, ReadManager™, Siren™, StereoSurround™, V²IU™, Visual Concert™, VS4000™, VSX™, and the industrial design of SoundStation are trademarks of Polycom, Inc. in the United States and various other countries. All other trademarks are the property of their respective owners.

Patent Information

The accompanying product is protected by one or more U.S. and foreign patents and/or pending patent applications held by Polycom, Inc.

Disclaimer

Some countries, states, or provinces do not allow the exclusion or limitation of implied warranties or the limitation of incidental or consequential damages for certain products supplied to consumers, or the limitation of liability for personal injury, so the above limitations and exclusions may be limited in their application to you. When the implied warranties are not allowed to be excluded in their entirety, they will be limited to the duration of the applicable written warranty. This warranty gives you specific legal rights which may vary depending on local law.

Copyright Notice

Portions of the software contained in this product are:
Copyright © 1998, 1999, 2000 Thai Open Source Software Center Ltd. and Clark Cooper
Copyright © 1998 by the Massachusetts Institute of Technology
Copyright © 1998-2003 The OpenSSL Project
Copyright © 1995-1998 Eric Young (eay@cryptsoft.com). All rights reserved
Copyright © 1995-2002 Jean-Loup Gailly and Mark Adler
Copyright © 1996 - 2004, Daniel Stenberg, <daniel@haxx.se>

Permission is hereby granted, free of charge, to any person obtaining a copy of this software and associated documentation files (the "Software"), to deal in the Software without restriction, including without limitation the rights to use, copy, modify, merge, publish, distribute, sublicense, and/or sell copies of the Software, and to permit persons to whom the Software is furnished to do so, subject to the following conditions:

The above copyright notice and this permission notice shall be included in all copies or substantial portions of the Software.

THE SOFTWARE IS PROVIDED "AS IS", WITHOUT WARRANTY OF ANY KIND, EXPRESS OR IMPLIED, INCLUDING BUT NOT LIMITED TO THE WARRANTIES OF MERCHANTABILITY, FITNESS FOR A PARTICULAR PURPOSE AND NONINFRINGEMENT. IN NO EVENT SHALL THE AUTHORS OR COPYRIGHT HOLDERS BE LIABLE FOR ANY CLAIM, DAMAGES OR OTHER LIABILITY, WHETHER IN AN ACTION OF CONTRACT, TORT OR OTHERWISE, ARISING FROM, OUT OF OR IN CONNECTION WITH THE SOFTWARE OR THE USE OR OTHER DEALINGS IN THE SOFTWARE.

© 2007 Polycom, Inc. All rights reserved.

Polycom Inc.
4750 Willow Road
Pleasanton, CA 94588-2708
USA

No part of this document may be reproduced or transmitted in any form or by any means, electronic or mechanical, for any purpose, without the express written permission of Polycom, Inc. Under the law, reproducing includes translating into another language or format.

As between the parties, Polycom, Inc. retains title to, and ownership of, all proprietary rights with respect to the software contained within its products. The software is protected by United States copyright laws and international treaty provision. Therefore, you must treat the software like any other copyrighted material (e.g. a book or sound recording).

Every effort has been made to ensure that the information in this manual is accurate. Polycom, Inc. is not responsible for printing or clerical errors. Information in this document is subject to change without notice.

About This Guide

Thank you for choosing the SoundPoint IP 650 SIP, a full-duplex, hands-free phone. This unit provides business telephony features and functions such as multiple call appearances, call hold, transfer, and conference over an IP network.

In this User Guide, you will find everything you need to quickly use your new phone. Be sure to verify with your system administrator that your network is prepared for configuring your SoundPoint IP 650 SIP phone. As well, be sure to read the [Parts List](#) and [Regulatory Notices](#) sections in this guide before you set up and use the SoundPoint IP 650 SIP phone. This information can also be found at <http://www.polycom.com/support/voip/>.

Contents

About This Guide	iii
1 Getting Started with Your SoundPoint IP 650 SIP Phone . . .	1-1
Parts List	1-2
Assembling Your SoundPoint IP 650 SIP Phone	1-3
Connecting Network and Power Source	1-3
Connecting the Handset and Optional Headset	1-5
Attaching the Base	1-6
Features of Your SoundPoint IP 650 SIP Phone	1-9
Using the Navigation Keys	1-12
2 Customizing Your SoundPoint IP 650 SIP Phone	2-1
Configuring Basic Settings	2-2
Appearance of Time and Date	2-2
Display Contrast	2-3
Backlight Intensity	2-4
Headset Memory Mode	2-6
Ring Type	2-7
Language Support	2-8
Muting the Microphone	2-8
Adjusting the Volume	2-9
Managing Call Lists	2-9
Managing Contacts	2-10
Adding Contacts	2-10
Editing Contacts	2-12
Deleting Contacts	2-13
Placing a Call to a Contact	2-14
Searching For a Contact	2-14
Managing Incoming Calls	2-15
Distinguishing Calls	2-15

Rejecting Calls	2-16
Diverting Calls	2-16
System Customizations	2-17
Supporting Multiple Lines	2-17
Supporting Multiple Line Keys Per Line	2-18
Supporting Shared Lines	2-19

3 Using the Basic Features of Your SoundPoint IP 650 SIP Phone 3-1

Placing a Call	3-2
Answering a Call	3-4
Ending a Call	3-8
Redialing a Number	3-8
Putting a Call on Hold	3-9
Setting Up a Conference	3-10
Transferring a Call	3-12
Forwarding Calls	3-14
Enabling Do Not Disturb	3-17
Assigning Speed Dial Keys	3-18
Using Voice Mail	3-20

4 Using the Advanced Features of Your SoundPoint IP 650 SIP Phone 4-1

Using Multiple Call Appearances	4-1
Using Text Messaging	4-3
Using Buddy Lists	4-5
Presence	4-5
Managing Buddies	4-6
Integrating With Microsoft Live Communications Server 2005	4-7
Restarting Your Phone	4-8

5 Using the SoundPoint IP Backlit Expansion Module 5-1

Parts List	5-2
Connecting the SoundPoint IP Backlit Expansion Module	5-3
Features of the SoundPoint IP Backlit Expansion Module	5-4
Adjusting the Display Contrast	5-5
Adjusting the Backlight	5-5
Placing a Call	5-5
Answering a Call	5-6

Assigning Speed Dial Keys 5-6
 Using the Busy Lamp Field 5-7

6 Troubleshooting Your SoundPoint IP 650 SIP Phone 6-1

Power and Startup 6-2
 Controls 6-3
 Access to Screens and Systems 6-4
 Calling 6-5
 Displays 6-7
 Audio 6-7

Regulatory Notices Regulatory Notices-1

Index Index-1

Getting Started with Your SoundPoint IP 650 SIP Phone

This chapter provides basic installation instructions and information for obtaining the best performance with the SoundPoint IP 650 phone.

The SoundPoint IP 650 provides a powerful, yet flexible IP communications solution, delivering excellent voice quality. The high-resolution graphic display supplies content for call information, multiple languages, directory access, and system status. The SoundPoint IP 650 supports advanced functionality, including multiple call and flexible line appearances, HTTPS secure provisioning, presence, custom ring tones, local conferencing, and Polycom's HD Voice technology.

When equipped with up to three SoundPoint IP Expansion Modules, the SoundPoint IP 650 delivers the advanced call handling capabilities of a high-performance attendant console.

This chapter contains:

- [Parts List](#)
- [Assembling Your SoundPoint IP 650 SIP Phone](#)
- [Features of Your SoundPoint IP 650 SIP Phone](#)
- [Using the Navigation Keys](#)

To customize your phone, refer to [Customizing Your SoundPoint IP 650 SIP Phone](#) on page 1-1. To read about the phone's basic features, refer to [Using the Basic Features of Your SoundPoint IP 650 SIP Phone](#) on page 3-1. To read the phone's advanced features, refer to [Using the Advanced Features of Your SoundPoint IP 650 SIP Phone](#) on page 4-1. To add a SoundPoint IP Expansion Module to your SoundPoint IP 650 phone, refer to [Using the SoundPoint IP Backlit Expansion Module](#) on page 5-1.

If you require additional information or assistance with your new phone, contact your system administrator.

Parts List

The following components are included in your SoundPoint IP 650 SIP package:

- Polycom SoundPoint IP 650 SIP phone

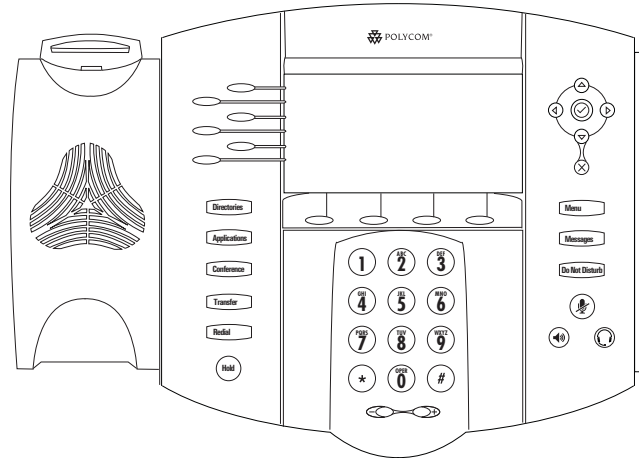

- handset & handset cord

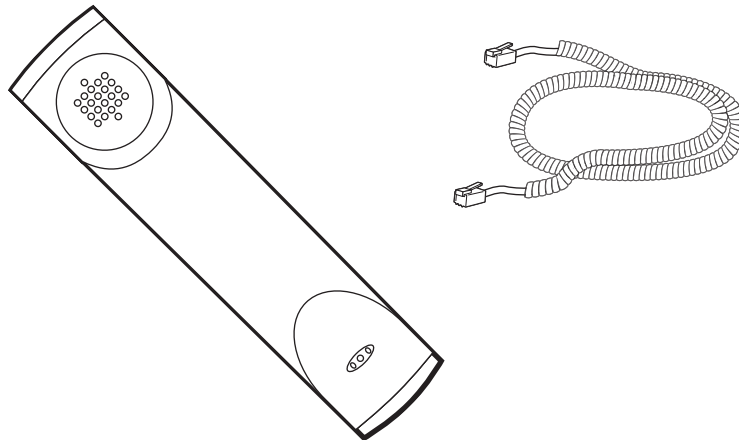

- Phone Base

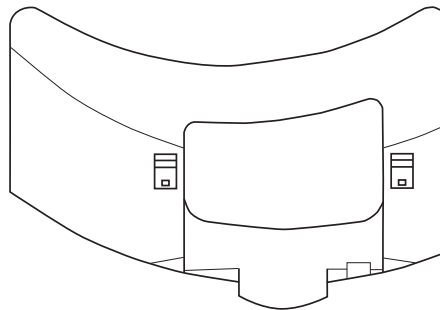

- Network / Power Cable

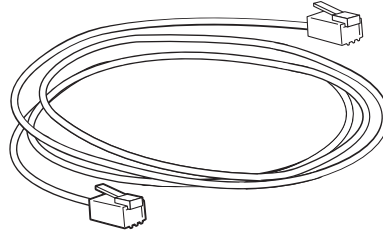

- Quick Start Guide and registration card

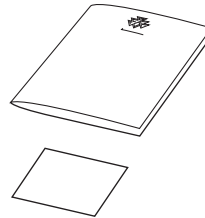

Check this list before installation to ensure that you have received each item. If you are missing any items, contact your system administrator.

Assembling Your SoundPoint IP 650 SIP Phone

This section describes how to assemble your SoundPoint IP 650 SIP phone:

- Connect network and power source
- Connect handset and headset (optional)
- Attach phone base

If your phone is already assembled, go directly to [Features of Your SoundPoint IP 650 SIP Phone](#) on page 1-9.

Connecting Network and Power Source

You have two options for network and power source connections. Your system administrator will advise you on which one to use.

You can use one of the following methods:

- AC power
- Power over Ethernet (PoE)

AC Power

To connect the AC power:

1. Connect the supplied network cable between the LAN jack on the phone and the LAN port on the wall or hub/switch device.
2. Connect the DC plug on the power adapter to the DC 24V jack marked on the phone.
3. Connect the country-specific AC cord to the power adapter.

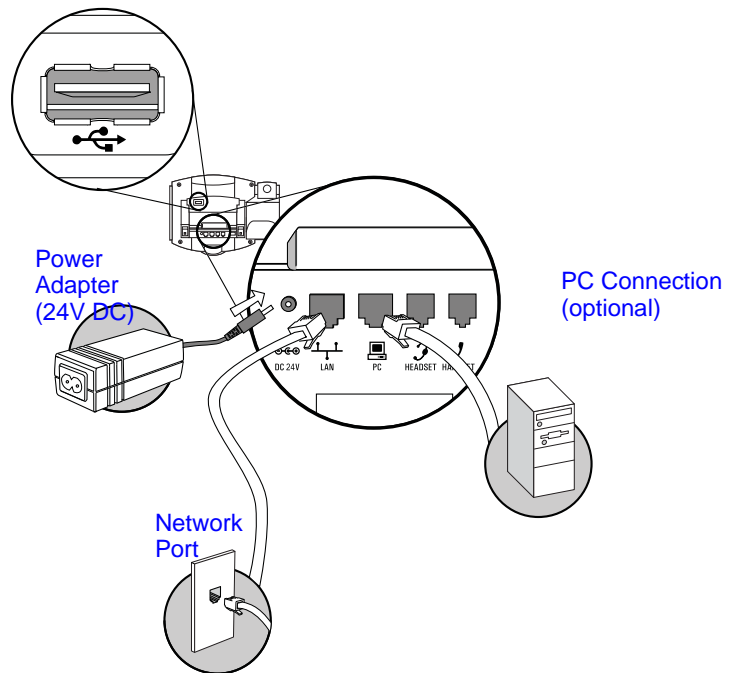

Power over Ethernet

Using a regular CAT5 cable (optional accessory from Polycom), the phone can be powered from a PoE (IEEE 802.3af) compliant switch or hub.

To connect the PoE:

- Plug the supplied network cable between the LAN jack on the phone and an available power and data port on the in-line power switch.

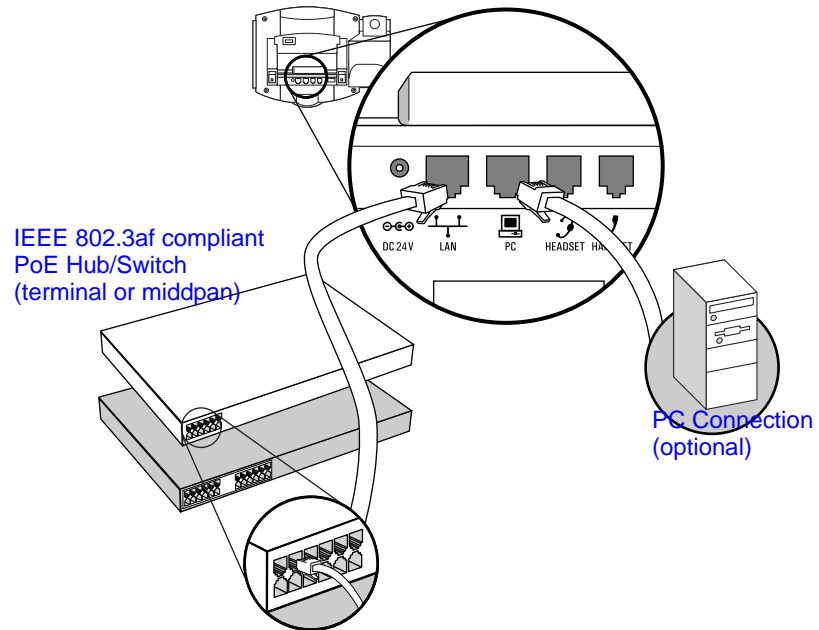

Connecting the Handset and Optional Headset

To connect the handset and optional headset:

1. Connect the short straight end of the phone cord to the handset and the corresponding longer straight end of the cord to the handset jack on the back of the phone.

2. Connect the headset (optional) to the headset jack on the back of the phone.

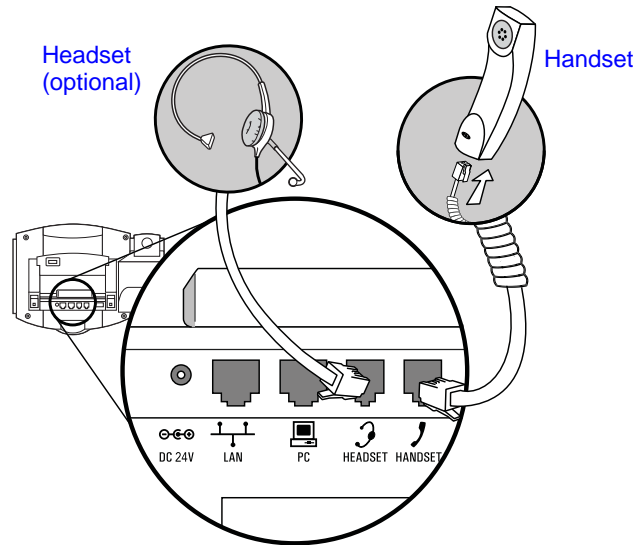

For information on supported headsets, go to www.polycom.com/support/voice and enter the string "Headset Compatibility List" in the Knowledge Base text box.

Attaching the Base

The phone base can be attached to the SoundPoint IP 650 in one of two ways:

- As a desk mount
- As a wall mount

To attach the base as a desk mount:

1. Place all cords in the recessed area above the modular jacks.

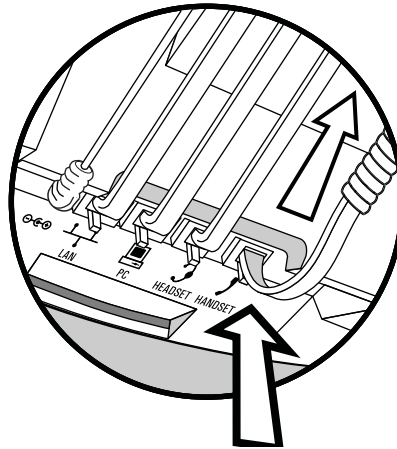

2. Align the two protrusions on the bracket with their corresponding holes in the phone.

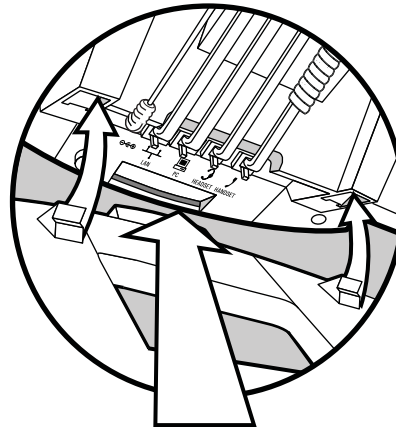

3. Snap them together to lock the base to the phone.

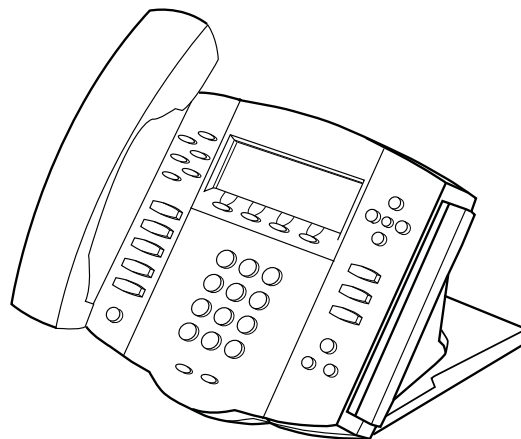

To attach the base as a wall mount:

1. Place all cords in the recessed area above the modular jacks.

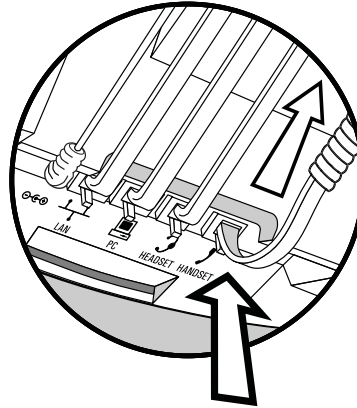

2. On the back of the phone, remove the key located behind the hook switch and reposition it so that the end tab (at a 45° angle) is facing up.

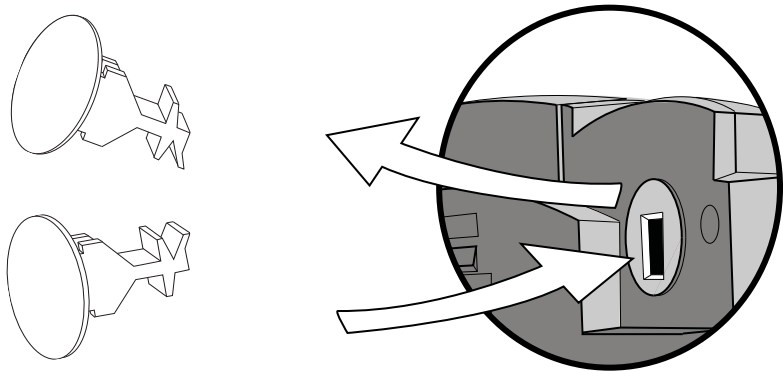

3. With mounting tab of the base unit facing up, fasten the base unit to the wall mount using wall anchors (not included).

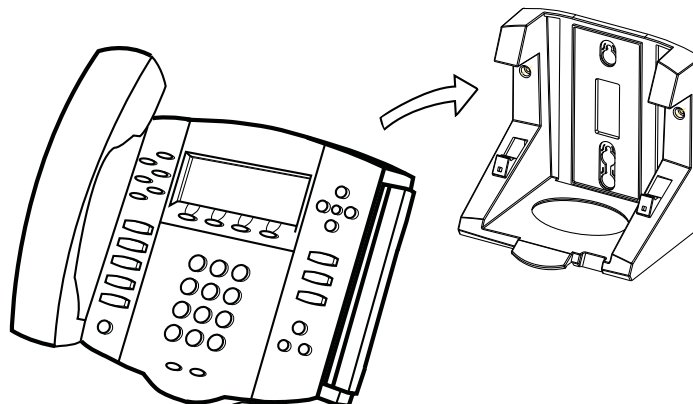



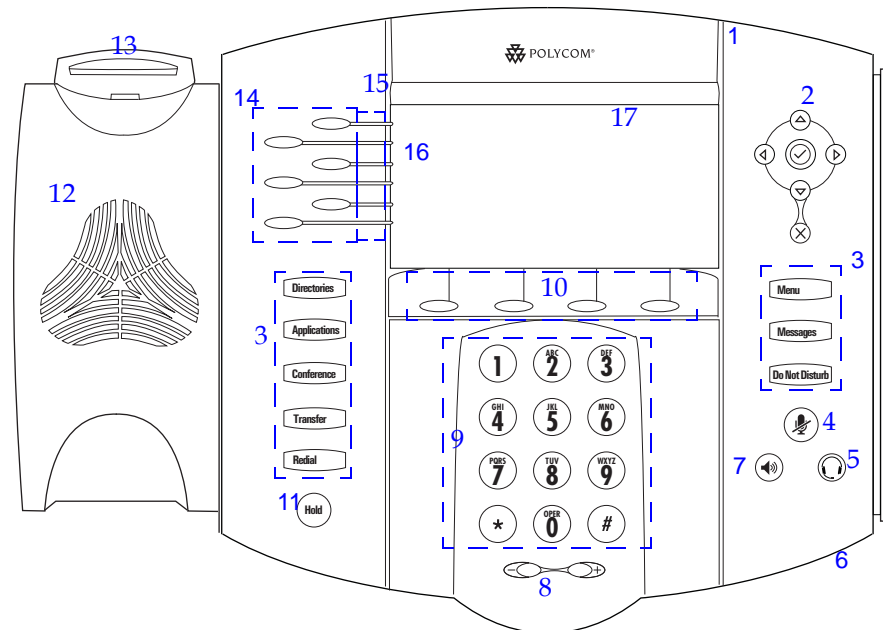

Note

The wall mount is not included in SoundPoint IP 650 SIP package. Contact your system administrator if you require one.

Features of Your SoundPoint IP 650 SIP Phone





The features of your SoundPoint IP 650 phone are:











- 1. Message Waiting Indicator** – This will alert you to voice and text (instant) messages.
- 2. Display Control Keys** – Use , , , and  (arrow keys) to scroll through the displayed information.

Use  to select a field of displayed data.

Use  to delete displayed data.

- 3. Feature Keys** – Access important features using these keys.

-  – Access to local directories and call lists.
-  – Access to special applications (contact system administrator).
-  – Allows setup of a local conference.

-  – Transfer of current call to third party.
 -  – Dials most recently dialed party.
 -  – Access local (your phone) and global (your organization) features.
 -  – Access and manage text and voice messages.
 -  – Cancels ringing and directs incoming calls to your Voice Mail (if supported).
4. **Microphone Mute**  – Mutes audio transmission locally during calls and conferences.
 5. **Headset**  – Allows you to place and receive calls through an optionally connected headset.
 6. **Hands-free Microphone** – Picks up audio during hands-free calls. Place your phone on a hard, flat surface for best results.
 7. **Speakerphone**  – Allows for hands-free communication during calls.
 8. **Volume Keys**  – Use these to adjust the volume of the handset, headset, speaker, and ringer.
 9. **Dial Pad** – These 12 keys provide the 10 digits, the alphabetic characters, and special characters available in context-sensitive applications.
 10. **Soft Keys** – These keys are automatically labeled to identify their context-sensitive functions.
 11. **Hold**  – Holds an active call or resumes a held call.
 12. **Speaker** – For ringer and hands-free audio output.
 13. **Hookswitch**
 14. **Line/Speed Dial Key** – Use these keys to activate up to six lines or speed dials that can be assigned to your phone.

15. Line Indicators – Individual multi-color LEDs display the dynamic call state and remote user status (busy lamp field (BLF) and presence). The mapping is:

- Solid green – An active call is in progress.
- Fast flashing green – There is an Incoming (ringing) call.
- Flashing green – The call is held by the other party.
- Flashing red – The call is on hold.
- Solid red – The line is busy remotely (shared lines).

16. Line Keys  – Use these keys to activate up to six lines or speed dials that can be assigned to your phone. The associated icons represent:

- Registered line 
- Registered shared line 
- Unregistered line 
- VoiceMail/Messages 
- Speed-Dial 
- Ringing 

– Call if progress with HD Voice

					
HD	HD	HD	HD	HD	



- Call Forward 
- Do Not Disturb 
- Conference 
- Presence/BLF 

17. Graphic Display – Shows information about calls, messages, soft keys, time, date, and other relevant data.

- Caller display information – first party, second party, number of calls
- Information display line (in order of precedence highest to lowest)
 - Popup text (like network errors)
 - Do Not Disturb text
 - Missed call text or second incoming caller display
 - Prompt text (like “Enter number”)
 - Time and date text (if idle display is not used for time/date display)





Using the Navigation Keys

To navigate through menus and to enter data, these are useful tips:

- Use  and  to scroll through the lists.

Note

Press the * key to page up. Press the # key to page down. These shortcuts can be used when lists appear on more than one page.

- When menus have submenus, use the  and  to move one level down and one level up.
- Press  to exit from any menu.
- Press  to exit from any directory.
- To enter text using the dial pad, press the number keys one or more times.

For example, for ‘A’ press ‘2’ and for ‘C’ press ‘222’. When in text entry mode, the title will show whether keys will generate numbers (1), upper-case (A), or lower-case (a) characters and the **1/A/a** soft key can change this.

Customizing Your SoundPoint IP 650 SIP Phone

You can customize your SoundPoint IP 650 phone by adjusting the setting for time and date, display contrast, and ring type, for example. You can add contacts to the phone's directory manually or from call lists. You can handle incoming calls from different contacts in different ways.

This chapter provides basic operating instructions for customizing your SoundPoint IP 650 SIP phone. This chapter contains instructions on:

- [Configuring Basic Settings](#)
- [Managing Call Lists](#)
- [Managing Contacts](#)
- [Managing Incoming Calls](#)

Some customizations of your SoundPoint IP 650 SIP phone are performed by your system administrator. These include:

- [Supporting Multiple Lines](#)
- [Supporting Multiple Line Keys Per Line](#)
- [Supporting Shared Lines](#)

To read about the phone's basic features, refer to [Using the Basic Features of Your SoundPoint IP 650 SIP Phone](#) on page 3-1. To read about the phone's advanced features, refer to [Using the Advanced Features of Your SoundPoint IP 650 SIP Phone](#) on page 4-1. To add a SoundPoint IP Expansion Module to your SoundPoint IP 650 phone, refer to [Using the SoundPoint IP Backlit Expansion Module](#) on page 5-1.

If you require additional information or assistance with your new phone, contact your system administrator.

Configuring Basic Settings

You can configure the following basic settings through use of  :

- The appearance of the time and date
- Display contrast
- Backlight intensity
- Headset Memory Mode
- Ring type
- Language support (localization)

You can mute the microphone and adjust the volume using separate keys.

Appearance of Time and Date

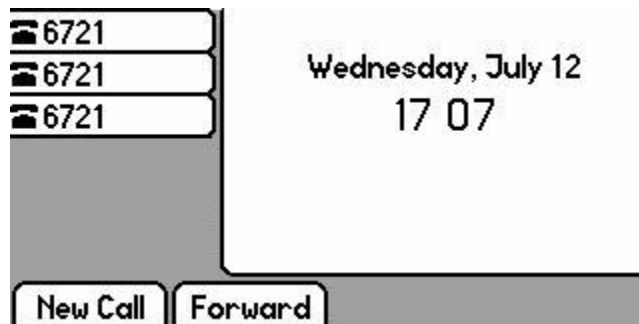

The time and date appears on the graphic display of the SoundPoint IP 650 phone. If the phone cannot obtain a time and date from the call server, the display will flash. Contact your system administrator if either the time or date is incorrect.

You have control over the format of the time and date display and can turn the display of time and date off. The default time and date format appears in the following figure.



To configure the time and date:

1. Press .
2. Select *Settings > Basic > Preferences > Time & Date*.
3. Select from *Clock Date*, *Clock Time*, *Clock Order*, or *Enable/Disable*.

4. Scroll through the options under each of these selections using the  and .
5. Press the **Select** soft key to confirm your choice.

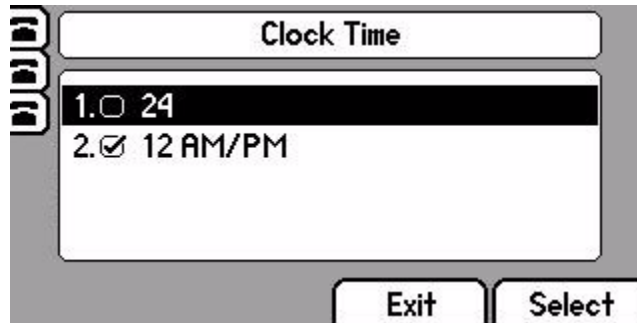

6. Press  or the **Exit** soft key repeatedly to return to the idle display.

Display Contrast

Note

If you want to change the display contrast on the SoundPoint IP Backlit Expansion Module, refer to [Adjusting the Display Contrast](#) on page 5-5.

To adjust the contrast on the display to a comfortable level:

1. Press .
2. Select *Settings > Basic > Contrast*.
3. Press the **Up** or **Down** soft keys to increase or decrease the display contrast.

Note

You can also use the volume keys to increase or decrease the display contrast.

4. Press the **Ok** or **Cancel** soft keys to accept or cancel changes.

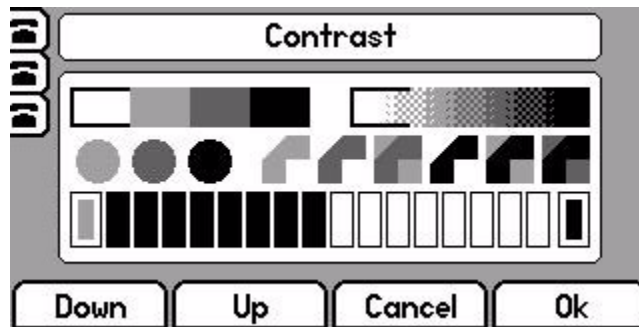

5. Press **Menu** or the **Exit** soft key repeatedly to return to the idle display.

Backlight Intensity

Backlight intensity on the SoundPoint IP 650 phone has three modes:

- Backlight On
- Backlight Idle
- Dim

You can modify the Backlight On intensity and the Backlight Idle intensity separately. You can select high, medium, low, and off levels for both.

Dim mode intensity is determined by the Backlight On intensity and the Backlight Idle intensity together as follows:

Backlight On Intensity	Backlight Idle Intensity	Dim Intensity
off	off	off
low	dimmer than low	low
medium	dimmer than medium	medium
high	off	medium
high	low	medium
high	medium	medium
high	high	high

The Backlight On mode turns on for following events:

- Any key press
- Hookswitch release

- Incoming calls
- Ending a call, holding a call, resuming a call by the other party
- A voice or instant message received
- A USB device plugged in or unplugged

If you do not press any keys on the phone, after 20 seconds of the backlight turning on, the backlight dims (or changes) to medium in the following cases:



- A call is in progress
- A call is on hold
- There is an incoming call (ringing)
- There is an outgoing call (ringing back)
- Any menu shows on the display

In all other cases, the mode changes to Backlight Idle.

To modify the backlight intensity:

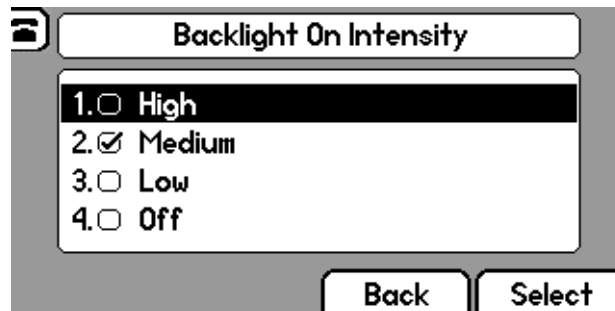
1. Press .
2. Select *Settings > Basic > Backlight Intensity*.
3. Select *Backlight On Intensity*.





4. Use the  or  to select high, medium, low, or off and press the **Select** soft key to modify the Backlight On Intensity.

The default level is medium.

5. Select *Backlight Idle Intensity*.





6. Use the  or  to select high, medium, low, or off and press the **Select** soft key to modify the Backlight On Intensity.

The default level is low.

Headset Memory Mode

This feature is especially useful for permanent or full-time headset users.

To permanently enable the Headset Memory Mode:

1. Press .
2. Select *Settings > Basic > Preferences > Headset Memory...*
3. Use the  or  to select Enabled and press the **Select** soft key to enable Headset Memory Mode.

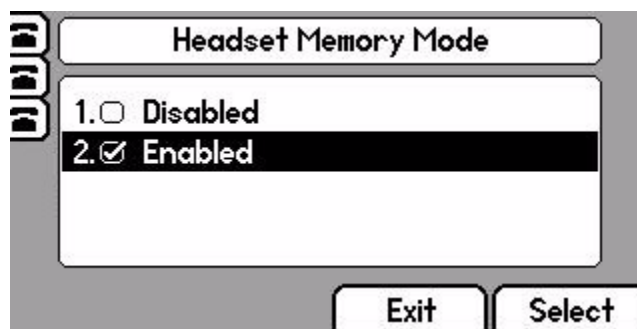

4. Press  or the **Exit** soft key repeatedly to return to the idle display.

Repeat steps 1 to 4 to select Disabled and turn Headset Memory Mode off.

To activate Headset Memory Mode:





>> Press  twice.

The flashing headset icon on the graphic display or a flashing headset key indicates that the headset mode is activated. Pressing  or **Answer** soft key to receive a call will now connect to the your headset automatically.

Ring Type

You can select from the different ring types to distinguish between lines or to have a different ring from your neighbor's phone. You can set distinctive incoming ringing tones for contacts in your local directory.

To change the incoming ring to a desired sound:

1. Press .
2. Select *Settings > Basic > Ring Type*.
3. (Optional) If multiple lines are configured on your phone, first select the line to change from the list using the  and .
4. Using the  and , select the desired ring type.
Press the **Play** soft key to hear the selected ring type.



5. Press the **Select** soft key to change to the selected ring type.
6. Press  or the **Exit** soft key repeatedly to return to the idle display.

Note

If you configure your SoundPoint IP 650 phone for silent ring, press the ringing Line key or the Answer soft key to answer the call. If your headset is off hook, the call is routed to the handset. If your handset is on hook, the call is routed to the speaker.

Language Support

Many languages are supported by the SoundPoint IP 650 phone.

To change the language:

1. Press .
2. Select *Settings > Basic > Preferences > Language*.
3. Scroll through the list of available languages.



4. Press the **Select** soft key when the desired language is highlighted.
Text that appears on the graphic display will change to the language of your choice.
5. Press  or the **Exit** soft key repeatedly to return to the idle display.

Muting the Microphone

During a call, press . The Message Waiting Indicator turns red and a microphone on the graphic display indicates that the other party (or parties) cannot hear you.

Microphone Mute applies to all modes: Handset, Headset, and Hands-free Speakerphone. You can still hear all other parties while mute is enabled.

To turn off Microphone Mute, press  again.

Adjusting the Volume

Press  to adjust receiver volume during a call. Pressing these keys in the idle state adjusts the ringer volume.

Note

To conform to regulatory requirements, handset and headset volume will return to a preset level after each call, but the configuration can be changed by your system administrator. Hands-free Speakerphone volume settings will be maintained across calls.

Managing Call Lists

Local lists of missed, received, and placed calls is maintained by the phone (up to 100 for each list).

Press  followed by *Call Lists > Missed Calls, Received Calls, or Placed Calls* as desired. The Placed Call list appears in the following figure.



To manage the listed calls:

- Select the **Edit** soft key to edit the dial string if necessary.
- Select the **Dial** soft key to return the call.
- Select the **Exit** soft key to return to the previous menu.

For additional choices, press the **More** soft key followed by:

- The **Info** soft key to view information about the call.
- The **Save** soft key to store the contact to the Contact Directory.
- The **Clear** soft key to delete the call from list.

Press the **More** and **Exit** soft keys repeatedly to return to the idle display.

Note

Press the **Right** arrow key from the idle display to access the Placed Calls list. Press the **Left** arrow key from the idle display to access the Received Calls list. Press the **Down** arrow from the idle display to access the Missed Calls list. These shortcuts can be used while placing calls or performing transferring and conferencing functions.

Note

You can manually clear the call lists. They are automatically cleared when you restart the phone.

Managing Contacts

You can store a large number of contacts in your phone's local contact directory. Contact your system administrator for the exact number.



Adding Contacts

You can add a contact manually or from a call list.

Adding Contacts Manually

To add a contact to the local contact directory manually:

1. Press  .
2. Select *Contact Directory*.
3. Press the **More** soft key.
4. Press the **Add** soft key.

5. Enter first and/or last name of the contact from the keypad.

Use the **1/A/a** soft key to select between numeric and upper/lower case alphanumeric modes.

Use the **Encoding** soft key to access special characters in other languages.

6. Enter a contact number.

This is a required field and it must be unique (not already in the directory).

7. Change the *Speed Dial Index* if desired.

It is automatically assigned to the next available index value.

For more information, refer to [Assigning Speed Dial Keys](#) on page 3-18.

8. Change the *Ring Type* and *Divert Contact* if desired.

These fields may be left blank.

For more information on setting the *Ring Type* field, refer to [Distinguishing Calls](#) on page 2-15.

For more information on diverting contacts, refer to [Diverting Calls](#) on page 2-16.

9. Change the *Auto Reject*, *Auto Divert*, *Watch Buddy*, and *Block Buddy* if desired.

Use  and  to switch between Enabled and Disabled settings.

For more information on setting the *Auto Reject* field, refer to [Rejecting Calls](#) on page 2-16.

10. Press the **Save** or **Cancel** soft keys to accept or cancel changes.

11. Press **Directories** or the **Exit** soft key repeatedly to return to the idle display.

Adding Contacts From Call Lists

To add a contact to the local contact directory from a call list:

1. Do one of the following steps:

- a. Press **Directories**.

Select *Call Lists > Missed Calls, Received Calls, or Placed Calls* as desired.

- b. Press **Left Arrow**, **Right Arrow**, or **Down Arrow** to access the desired call list.
2. Use the **Up Arrow** and **Down Arrow** to scroll through the list to find the contact.
You can also use the * key to Page Up and the # key to Page Down.
3. Press the **More** soft key, and then the **Save** soft key to save the contact in the phone's directory.



4. Press **Directories** or the **Exit** soft key repeatedly to return to the idle display.



Note

At this point, you may want to go to the local contact directory, check whether the contact was saved correctly, and add missing fields.

Editing Contacts

To edit a contact in the local contact directory:

1. Press **Directories**.

2. Select *Contact Directory*.
3. Use  and  to scroll through the list to find the contact.
You can also use the * key to Page Up and the # key to Page Down.
4. Press the **Edit** soft key
5. Make the desired changes.







6. Press the **Save** or **Cancel** soft keys to accept or cancel changes.
7. Press  or the **Exit** soft key repeatedly to return to the idle display.

Note

You can also edit a contact associated with a speed dial key by pressing and holding that speed dial key and then following the steps 5 to 7 above.

Deleting Contacts

To delete a contact from the local contact directory:

1. Press .
2. Select *Contact Directory*.
3. Use  and  to scroll through the list to find the contact.
You can also use the * key to Page Up and the # key to Page Down.
4. Press the **More** soft key twice, and then the **Delete** soft key.
The contact is deleted from the directory.
5. Press  or the **Exit** soft key repeatedly to return to the idle display.

Placing a Call to a Contact

To place a call to a contact in the local contact directory:

1. Press **Directories**.
2. Select *Contact Directory*.
3. Use **▲** and **▼** to scroll through the list to find the contact.
You can also use the * key to Page Up and the # key to Page Down.
4. Press the **Dial** soft key.

Searching For a Contact

To search for a particular contact in the local contact directory:

1. Press **Directories**.
2. Select *Contact Directory*.
3. Press the **More** soft key, and then the **Search** soft key.
4. Using the dial pad, enter the first few characters of the contacts' first or last names.



5. Press the **Search** soft key again to search the contacts.
You can dial any successful matches from the resulting information on the graphic display.

Managing Incoming Calls

You can distinguish incoming calls from contacts in your directory by setting up distinctive rings, sending them directly to your voice mail, or by transferring them directly to another party.

Distinguishing Calls

You can customize your phone so that you can distinguish different parties by ring type.

To set a distinctive ring type for a particular contact:

1. Press **Directories**.
2. Select *Contact Directory*.
3. Use \triangle and ∇ to scroll through the list to find the contact.
You can also use the * key to Page Up and the # key to Page Down.
4. Press the **Edit** soft key and scroll down to the *Ring Type* field.



5. Enter the number corresponding to one of the ring types available.
For more information, refer to [Ring Type](#) on page 2-7.
6. (Optional) To remove an existing value, press \triangleright followed by \otimes .
7. Press the **Save** or **Cancel** soft keys to accept or cancel changes.
8. Press **Directories** or the **Exit** soft key repeatedly to return to the idle display.

Note

This feature is local to the phone, and may be over-ridden by your organization's settings. For more information, contact your system administrator.

Rejecting Calls

You can customize your phone so that incoming calls from a particular party are immediately sent to your voice mail.

Note

Rejecting calls is not available on shared lines.

To send incoming calls from a particular contact directly to voice mail:

1. Press **Directories**.
2. Select *Contact Directory*.
3. Use **▲** and **▼** to scroll through the list to find the contact.
You can also use the * key to Page Up and the # key to Page Down.
4. Press the **Edit** soft key and scroll down to the *Auto Reject* field.





5. Use the **◀** and **▶** to select Enabled.
6. Press the **Save** or **Cancel** soft keys to accept or cancel changes.
7. Press **Directories** or the **Exit** soft key repeatedly to return to the idle display.

Diverting Calls



You can customize your phone so that incoming calls from a particular party are transferred directly to a third party.

To divert incoming calls from a particular contact:

1. Press **Directories**.
2. Select *Contact Directory*.

3. Use  and  to scroll through the list to find the contact.
You can also use the * key to Page Up and the # key to Page Down.
4. Press the **Edit** soft key and scroll down to the *Divert Contact* field.



5. Enter the number of the party to whom you want to divert the call.
6. Scroll down to the *Auto Divert* field.
7. Use the  and  to select Enabled.
8. Press the **Save** or **Cancel** soft keys to accept or cancel changes.
9. Press  or the **Exit** soft key repeatedly to return to the idle display.

System Customizations

The following section details customizations of your SoundPoint IP 650 SIP phone that are performed by your system administrator.

Supporting Multiple Lines

Your SoundPoint IP 650 SIP phone can support up to 34 lines with or without a SoundPoint IP Backlit Expansion Module. For more information, refer to [Using the SoundPoint IP Backlit Expansion Module](#) on page 5-1.

Typically, the top-most Line Key is reserved for the principal directory number (DN) of the phone.

Depending on how your phone is configured, the display could resemble one of the following figures:

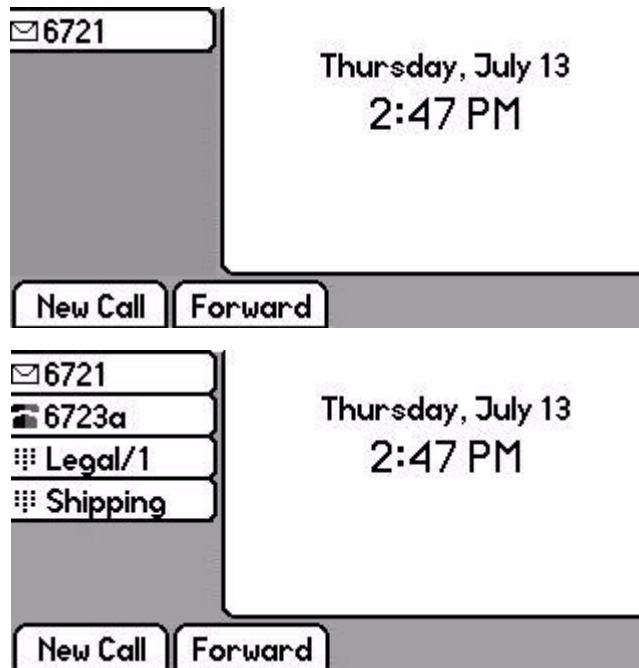

Supporting Multiple Line Keys Per Line

Each line on the phone can be configured to have more than one Line Key associated with it. This enhances call visualization and simplifies call handling. If this is the case, the display could resemble the following figure:

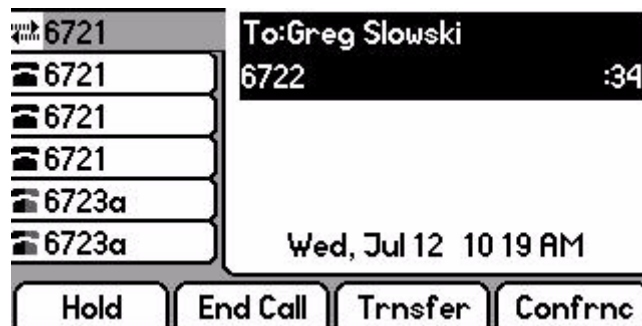

Incoming calls to this line will be distributed evenly among the available Line Keys. Similarly, outgoing calls will be distributed.

Your phone can be configured to have a combination of lines with a single Line Key and lines with multiple Line Keys.

Supporting Shared Lines

Your SoundPoint IP 650 SIP supports shared lines. A shared line is indicated by a different line icon. In the following figure, the line 6721 is private and the line 6723 is shared.

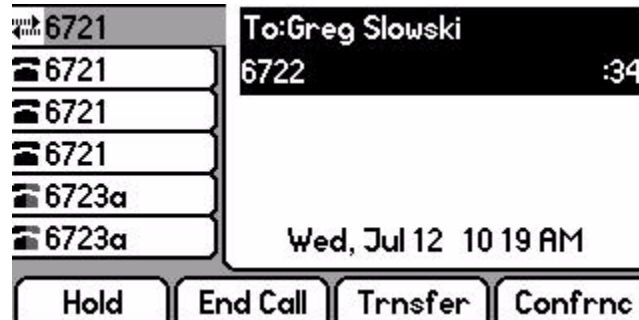

If two phones share a line, an incoming call to that number will cause both phones to ring. The call can be answered on either phone but not both.

Calls on shared lines can be transferred, put on hold, or added to a conference.

Note

Shared lines are an optional feature and may not be supported on your particular system. For more information, contact your system administrator.

Note

Call Forwarding is not available on shared lines.

Do Not Disturb (DND) on shared lines disables the ringing option only, the visual indication is still in place.

Using the Basic Features of Your SoundPoint IP 650 SIP Phone

Your SoundPoint IP 650 SIP phone is designed to be used like a regular phone on a public switched telephone network (PSTN). You call place calls, transfer a call to someone else, or conduct a conference call.

At any time, at most one active call may be in progress on your phone. The active call is the one that has audio associated with it. There may be multiple other calls:

- On hold
- In an “Incoming call” or “Ringing” state

This chapter provides basic operating instructions for the SoundPoint IP 650 SIP phone. This chapter contains instructions on:

- [Placing a Call](#)
- [Answering a Call](#)
- [Ending a Call](#)
- [Redialing a Number](#)
- [Putting a Call on Hold](#)
- [Setting Up a Conference](#)
- [Transferring a Call](#)
- [Forwarding Calls](#)
- [Enabling Do Not Disturb](#)
- [Assigning Speed Dial Keys](#)
- [Using Voice Mail](#)

To customize your phone, refer to [Customizing Your SoundPoint IP 650 SIP Phone](#) on page 2-1. To read about the phone’s advanced features, refer to [Using the Advanced Features of Your SoundPoint IP 650 SIP Phone](#) on page

4-1. To add a SoundPoint IP Expansion Module to your SoundPoint IP 650 phone, refer to [Using the SoundPoint IP Backlit Expansion Module](#) on page 5-1.

If you require additional information or assistance with your new phone, contact your system administrator.



Placing a Call

You can place a call in many ways using your SoundPoint IP 650 SIP phone:

- using the handset
- using the speakerphone
- using the headset

You can also dial the number first, and then choose the method you will use to speak to the other party.

You can search the local contact directory and dial from the search results page.

During a call, you can alternate between Handset, Headset, or Hands-Free Speakerphone modes by pressing the  or  keys, or picking up the handset.

Call duration on an active call is monitored through a local call timer. This is visible within the active call window on the graphic display. In the figure below, the call to Greg Slowski has lasted 34 seconds so far.

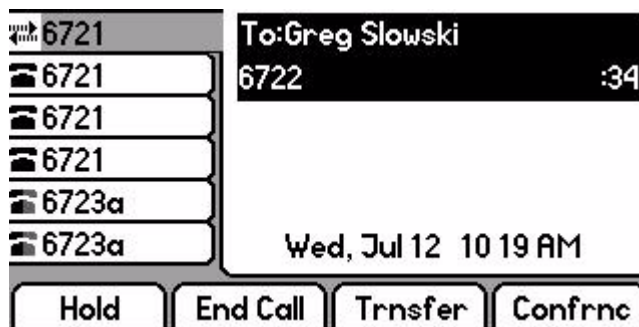

To place a call using the handset:

1. Do the following steps in any order:
 - Pick up the handset.
 - Dial the desired number using the dial pad.

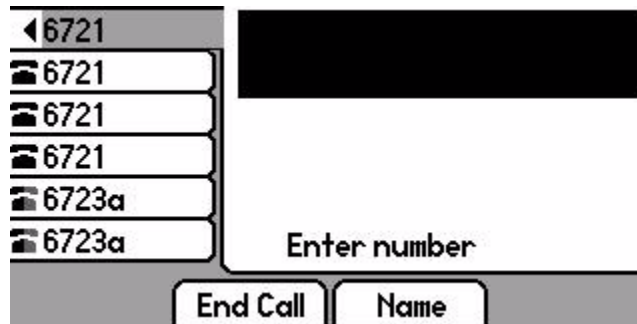



**Note**

You can also dial using the SIP URL or IP address. To obtain the IP address of your phone, press followed by followed by *Status > Platform > Phone*. The IP address is listed together with other phone information. For example, 10.3.0.42, sip: jane@polycom.com.



Press the **Name** soft key and enter the URL or IP address. Use * for "." and # for "@". Then press the **Send** soft key to complete the call.

Support for SIP URL or IP address calling may be disabled. Contact your system administrator.

To place a call using Hands-Free Speakerphone mode:

1. Do one of the following steps:
 - a With the handset on-hook, press , , or the **NewCall** soft key to obtain dial tone.
Dial the desired number using the dial pad.
 - b With the handset on-hook, dial the desired number using the dial pad.
Press , , or the **Dial** soft key.

To place a call using the headset:

1. Do one of the following steps:
 - a With the optional headset connected, press  or the **NewCall** soft key to obtain dial tone.
Press  .
Dial the desired number using the dial pad.
 - b With the optional headset connected, dial the desired number using the dial pad.
Press  .

Note

To permanently enable your headset, refer to [Headset Memory Mode](#) on page 2-6.

Answering a Call

When you are not in another call, you can answer a call in three basic ways using your SoundPoint IP 650 phone:

- using the handset
- using the speakerphone
- using the headset

The steps for answering an incoming call when you are in another call are different if your phone is configured for:

- A single Line Key per line



- Multiple Line Keys per line

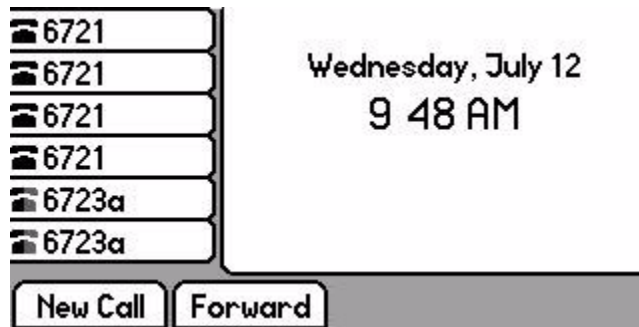

If your phone is configured with multiple call appearances, refer to [Using Multiple Call Appearances](#) on page 4-1 for instructions on how to answer a call.

Note

Incoming calls may be ignored by pressing the **Reject** soft key (for private lines) or the **Silence** soft key (for shared lines) or **Do Not Disturb** during ringing. The Do Not Disturb mode stays active when the call is dropped and will remain so until toggled off.

Incoming calls may be forwarded by pressing the **Forward** soft key. For more information, refer to [Dynamic Forwarding](#) on page 3-17.

When your SoundPoint IP 650 phone is configured for silent ring, press the ringing Line key or the **Answer** soft key and you will answer the call. If your handset is off hook, the call is routed to the handset. If your handset is on hook, the call is routed to the speaker.

Answering When Not in Another Call



In all cases, the active call will appear on the graphic display showing call duration and destination.

To answer a call using the handset:

>> Pick up the handset.

To answer a call using Hands-Free Speakerphone mode:

>> Do one of the following steps:

- Press .
- With the handset on-hook, press  opposite the incoming call (where the line status indicator is flashing green).
- Press the **Answer** soft key.

To answer a call using the headset:

>> Press  to answer the call through an optionally connected headset.

If Headset Memory Mode is activated, press  or the **Answer** soft key.

Answering When in Another Call

You are busy on an active call and a second incoming call arrives on the same phone number.

- If your phone is configured for a single Line Key per line:
 - The second call may cause a call waiting tone to be played and you see the second call appearance. Caller information for the incoming call appears on the graphic display.
- If your phone is configured for multiple Line Keys per line:
 - The second call may cause a call waiting tone to be played, the second Line Key indicator to fast flash green, and an incoming call icon appears. Caller information for the second Line Key appears on the bottom line of the graphic display.

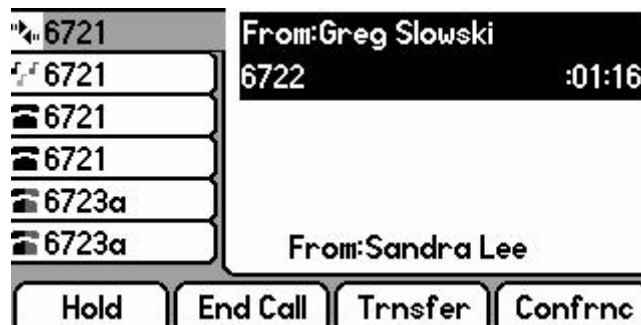

- If your phone is configured for shared lines:
 - The second call may cause a call waiting tone to be played, the second Line Key indicator to fast flash green, and an incoming call icon appears on the second Line Key.

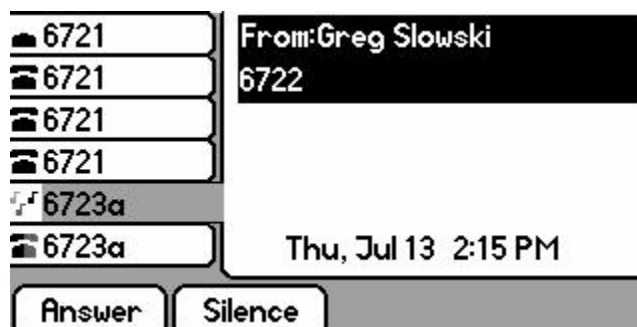



Note

If your phone is also configured for shared lines, the **Reject** soft-key is replaced by a **Silence** soft key and there is no the **Forward** soft-key. Pressing the **Silence** soft key will stop the ringing for that call.

To answer an incoming call on a line configured for a single Line Key:

>> Do one of the following steps:

- Press  or the **Hold** soft key to put the original call on hold.
- Press  to access the new call.

Soft key labels are updated on the display showing **Answer**, **Reject**, and **Forward**.

Answer the incoming call.

This places the original call on hold and refreshes the soft key labels.

Note

Incoming calls may be forwarded by pressing the **Forward** soft key. For more information, refer to [Dynamic Forwarding](#) on page 3-17.

To answer an incoming call on a line configured for multiple Line Keys:

>> Do one of the following steps:

- Answer the call by pressing  associated with the second incoming call.

The first call is put on hold and the second call is answered.

- Press  or the **Hold** soft key to put the original call on hold.

Soft key labels are updated on the display showing **Answer**, **Reject**, and **Forward**.

Answer the incoming call.

This places the original call on hold and refreshes the soft key labels.

Note

Incoming calls may be forwarded by pressing the **Forward** soft key. For more information, refer to [Dynamic Forwarding](#) on page 3-17.

To answer an incoming call on a shared line:



1. Answer the incoming call.
2. Press  or the **Hold** soft key.

Anyone on another phone configured to use the same shared line may take the call by selecting the Line Key associated with the on hold call (represented by a flashing red LED).

Ending a Call

To end a call:

>> Do one of the following steps:

- Press the **EndCall** soft key.
- Replace the handset.
- Press  if in Hands-free Speakerphone Mode, or  if in Headset Mode.

Redialing a Number



To redial the last call placed from your phone:

>> Press  .

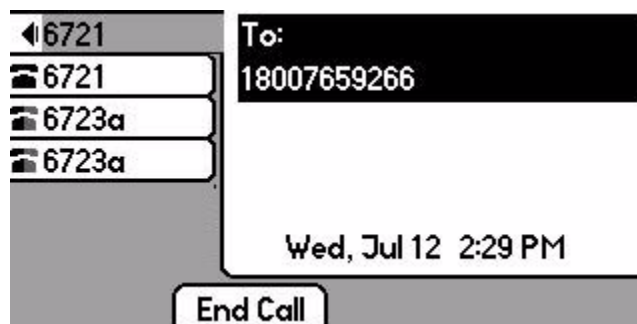
A call to your last placed call is attempted.



To redial a previously placed call:

- Do one of the following steps:
 - Press  from the idle display to access the Placed Calls list, scroll through the list to find the specific call.
 - Press  and select *Call Lists > Placed Calls*, and then scroll through the list to find the specific call.

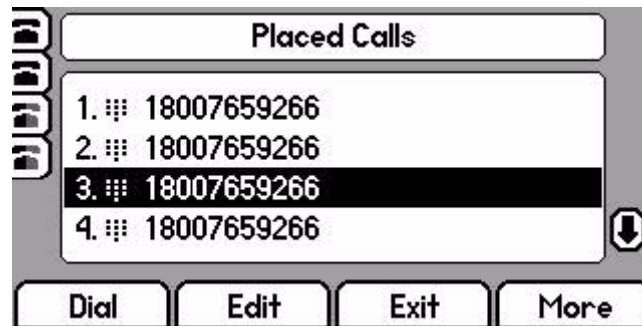

- Press the **Dial** soft key.

Note

These steps also apply to the Missed Call and Received Call lists.

Putting a Call on Hold

During a call, press  or the **Hold** soft key. This will be indicated on the graphic display by the hold icon as the line indicator.





Press  again or the **Resume** soft key to retrieve the call. The registered line icon appears as the line indicator.

Note

As using the Hold feature typically generates music or a beeping tone, avoid putting a conference call on hold.

Multiple Calls on Hold

If multiple calls are on hold on a single Line Key, use the  and  to switch between the calls, then press the **Resume** soft key to retrieve the desired call.



If more than two calls are on hold on a single Line Key, an indication appears on the graphic display, for example "2/3", indicating that this is the second call out of three calls.

If calls are on hold on more than one Line Key, the details of the calls on any Line Key can be viewed by pressing that Line Key and holding it down for a more than two seconds. If a Line Key is depressed for less than a second, the first call on hold on that Line Key will be retrieved.

Setting Up a Conference

You can create a conference with other parties using the phone's local conference feature. A conference may be created at any time between an active call and a call on hold (on the same or another line) by pressing the **More** and **Join** soft keys.

To set up a conference:

1. Call the first party.

Note

You can either dial the phone number directly or search for the number in the Contact Directory or Call Lists. For more information, refer to [Placing a Call](#) on page 3-2, [Searching For a Contact](#) on page 2-14, or [Managing Call Lists](#) on page 2-9.

2. Press **Conference** or the **Confrnc** soft key to create a new call.

The active call is placed on hold.

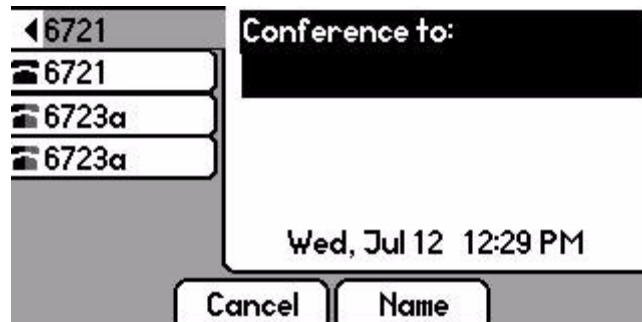

3. Call the second party.
4. When the second party answers, press **Conference** or the **Confrnc** soft key again to join all parties in the conference.



To split a conference call:

- >> Press the **Split** soft key to split the conference.
Both parties will be on hold.

To end a conference call:

- >> Press the **EndCall** soft key or hang up.
The other parties will continue to be connected.

Transferring a Call

A call can be transferred in one of three ways:

- Consultative transfer – The party to whom you want to transfer the call answers their phone before you transfer the call or hang up. You can consult with them before completing the transfer.
 - [To transfer a call](#): on page 3-12.
- Blind transfer – The call is automatically transferred after you dial the number of the party to whom you want to transfer the call.
 - [To perform a blind transfer](#): on page 3-13.
- Attended transfer – The parties are automatically connected to each other after you exit the conference.
 - Set up a conference call and then end your participation. For more information, refer to [Setting Up a Conference](#) on page 3-10.

To transfer a call:

1. During a call, press  or the **Transfer** soft key.

The active call is placed on hold.

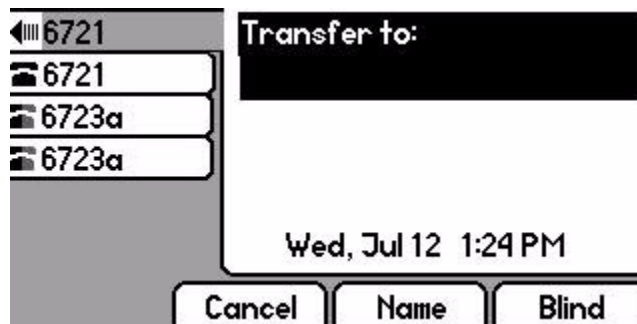

2. Do one of the following steps:
 - Enter the number to which you want to transfer the call.
 - Press **Directories**, select *Contact Directory*, use \triangle and ∇ to access the number, and then press the **Dial** soft key.
 - Press **Directories**, select *Call Lists*, select the appropriate list, use \triangle and ∇ to access the number, and then select the **Dial** soft key.
 - Press \triangleleft , \triangleright , or ∇ to access the desired call list, use \triangle and ∇ to access the number, and then select the **Dial** soft key.
3. As soon as the ring-back sound is heard or after the party answers, press **Transfer** or the **Trnsfer** soft key to complete the transfer.



You can talk privately to the party to which you are transferring the call before the transfer is completed.

If you are using a handset, the transfer can be completed by putting the handset on the cradle.

You can cancel the transfer before the call connects by pressing the **Cancel** soft key.

To perform a blind transfer:

1. During a call, press **Transfer** or the **Trnsfer** soft key.

2. Press the **Blind** soft key.

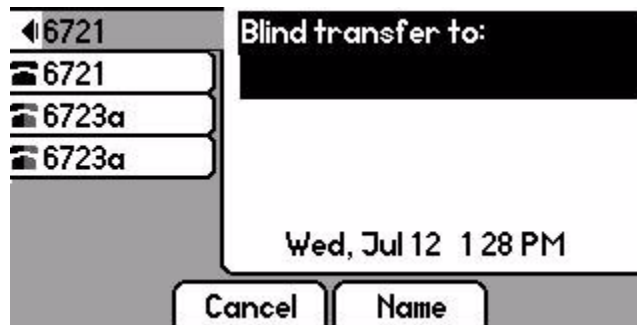

3. Do one of the following steps:
 - Enter the number to which you want to transfer the call.
 - Press **Directories**, select *Contact Directory*, use \triangle and ∇ to access the number, and then select the **Dial** soft key.
 - Press **Directories**, select *Call Lists*, select the appropriate list, use \triangle and ∇ to access the number, and then select the **Dial** soft key.

At this point, the call is connected to the number to which you are transferring them.

Forwarding Calls

You can configure your phone so that all incoming calls are forwarded to another party (known as static forwarding). You can also forward calls while the phone is ringing (known as dynamic forwarding).

All incoming calls can be forwarded to another party while Do Not Disturb is enabled on your phone. For more information, contact your system administrator.

Note

Call Forwarding is not available on shared lines.





This feature is local to the phone, and may be overridden by call server settings. For more information, contact your system administrator.

Static Forwarding

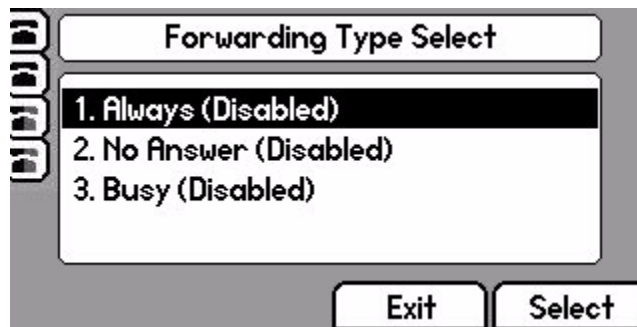
To enable call forwarding to another party:

1. Do one of the following steps:
 - Press  and select *Features > Forward...*
 - Press the **Forward** soft key from the idle display.



2. (Optional) If multiple lines are configured on your phone, select the line to forward from the list using  and .
3. Using  and , select the forwarding type you want to change and then press the **Select** soft key. The options are:
 - **Always** – For all incoming calls
 - **No Answer** – Once all options to accept calls have been taken
 - **Busy** – When you are already in a call
4. Depending on your selection:
 - a If you select **Always**, enter a number to forward all future incoming calls to.

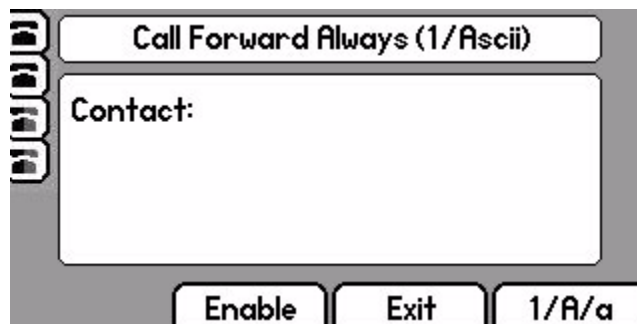

- b** If you select **No Answer**, enter a number to forward all unanswered incoming calls to and how many rings to wait before forwarding (one ring is approximately six seconds). A value of 2 is recommended.

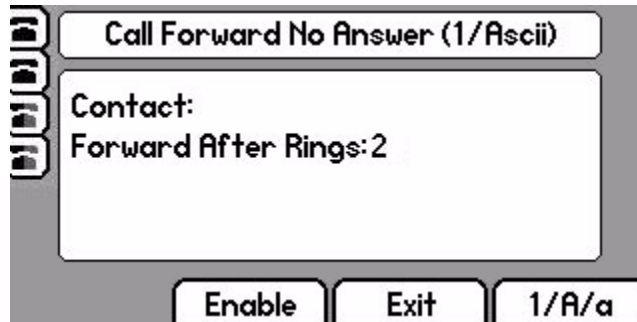

- c** If you select **Busy**, enter a number to forward all future incoming calls to when you are already in another call.

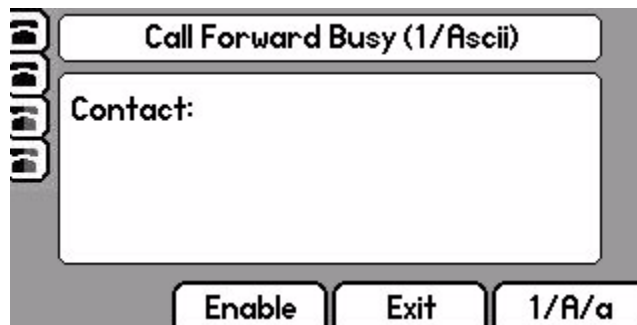



Note



You can also enter the SIP URL or IP address. For more information on using a SIP URL or IP address, refer to [To place a call using the handset:](#) on page 3-3

5. Select the **Enable** soft key to confirm call forwarding.
Select the **Exit** soft key to cancel any changes.

The idle display returns with a moving arrow as the line label to confirm call forwarding is enabled.

To disable call forwarding:

1. Do one of the following steps:
 - Press  and select *Features > Forward...*
 - Press the **Forward** soft key from the idle display.
2. (Optional) If multiple lines are configured on your phone, select the line to forward from the list using  and .

3. Using  and , select the forwarding type you want to change and then press the **Select** soft key.
4. Press the **Disable** soft key to turn off call forwarding.
The idle display returns and the regular icon appears as the line indicator.

Dynamic Forwarding

To forward an incoming call to another party:

1. With the phone ringing, press the **Forward** soft key.
2. Enter a number to forward the incoming call to.
3. Press the **Enable** soft key.

The incoming call is forwarded to the other party. If call forwarding is disabled, all future calls will not be forwarded and forwarding will remain disabled.

Enabling Do Not Disturb

Press  to prevent the phone from ringing on incoming calls. A flashing icon and text on the graphic display indicates that Do Not Disturb is on.





Calls received while Do Not Disturb is enabled are logged in the Missed Calls list unless configured to be forwarded to another party by your system administrator.

To disable Do Not Disturb, press  again.

Note

This feature is local to the phone, and may be overridden by call server settings. For more information, contact your system administrator.

Multiple Lines and Do Not Disturb

If multiple lines are configured on your phone, Do Not Disturb can be set on a line-by-line basis from the list using  and . For more information, contact your system administrator. When Do Not Disturb is enabled for a particular line, this is indicated by a flashing “X” beside the line indicator on the display.

Assigning Speed Dial Keys

You can associate contacts with Line Keys for single touch dialing of frequently used numbers. Speed Dial entries are consecutively placed next to assigned Line Keys on the phone. When a new entry is added to the Contact Directory, it is automatically assigned the next available speed dial index.

For example in the figure below, press the fourth Line Key to dial the shipping department.

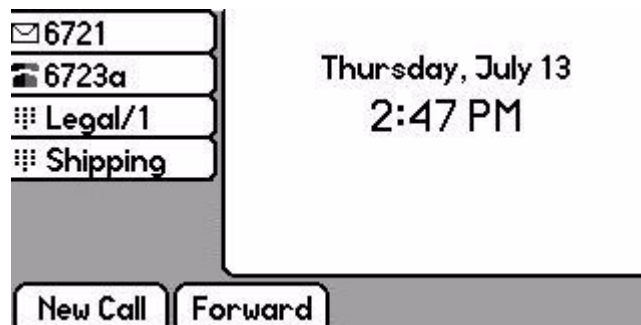



Note

Press the **Up** arrow key from the idle display to access the Speed Dial Index list directly. This shortcut can be used while performing transferring and conferencing functions.



Assigning New Speed Dial Keys

To add or edit a speed dial index for an existing contact:

1. Press .
2. Select *Contact Directory*.

3. Use  and  to scroll through the list to find the contact.
You can also use the * key to Page Up and the # key to Page Down.



4. Do one of the following steps:
- Enter the next available speed dial index.
 - Delete the existing speed dial index by using  followed by , and then enter a new speed dial index.
 - Press and hold an unassigned .

The next available speed dial index will be assigned automatically.

5. Press the **Save** or **Cancel** soft keys to accept or cancel changes.
6. Press  or the **Exit** soft key repeatedly to return to the idle display.

To assign a new speed dial key:

1. Press and hold an unassigned .

A new empty entry in the contact directory is automatically opened allowing contact information to be added.
2. Press the **More** soft key.
3. Press the **Add** soft key.
4. Enter first and/or last name of the contact from the keypad.

Use the **1/A/a** soft key to select between numeric and upper/lower case alphanumeric modes.

Use the **Encoding** soft key to access special characters in other languages.
5. Enter a contact number.

This is a required field and it must be unique (not already in the directory).
6. Change the *Speed Dial Index*.

The index can be any value between the next available index value and the maximum (9999).



Polycom recommends that you assign speed dial index values consecutively. For example, if the third Line Key is assigned to the speed dial index value "2", assign the fourth Line Key the speed dial index value "3".

7. Press the **Save** or **Cancel** soft keys to accept or cancel changes.
8. Press  or the **Exit** soft key repeatedly to return to the idle display.

Using Voice Mail

Your voice mail is saved in a centralized location and may be accessed from your phone.

The presence of new Voice Mail messages is indicated by a flashing Message Waiting Indicator LED on the front of the phone and a visual notification on the graphic display. If the phone is configured for multiple lines, an individual line indicator icon indicates Voice Mail messages left on that line.

A stutter dial tone in place of normal dial tone is used to indicate that one or more voice messages are waiting at the message center.

Note

Voice Mail is an optional feature configured on the call server and may not be supported on your particular system. For more information, contact your system administrator.

Screen options may vary with your application. Voice Mail may be accessible with a single key press. Contact your system administrator about this option.

To listen to voice messages:

1. Press  .
2. Follow voice or visual prompts on the graphic display to retrieve your messages.

If multiple lines are configured on your phone, select from which line messages are to be retrieved.

Using the Advanced Features of Your SoundPoint IP 650 SIP Phone

This chapter provides operating instructions for the advanced features of the SoundPoint IP 650 SIP phone. This chapter contains instructions on:

- [Using Multiple Call Appearances](#)
- [Using Text Messaging](#)
- [Using Buddy Lists](#)
- [Restarting Your Phone](#)

To customize your phone, refer to [Customizing Your SoundPoint IP 650 SIP Phone](#) on page 2-1. To read about the phone's basic features, refer to [Using the Basic Features of Your SoundPoint IP 650 SIP Phone](#) on page 3-1. To add a SoundPoint IP Expansion Module to your SoundPoint IP 650 phone, refer to [Using the SoundPoint IP Backlit Expansion Module](#) on page 5-1.

If you require additional information or assistance with your new phone, contact your system administrator.

Using Multiple Call Appearances

Each line on the phone can be configured to have one or more call appearances. More than one call appearances is useful if there is an active call and an incoming call arrives on the same line.

For example, the first figure shows extension 6721 in an outbound call with 6722.

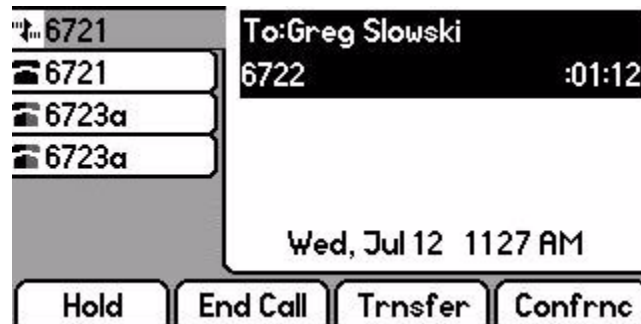

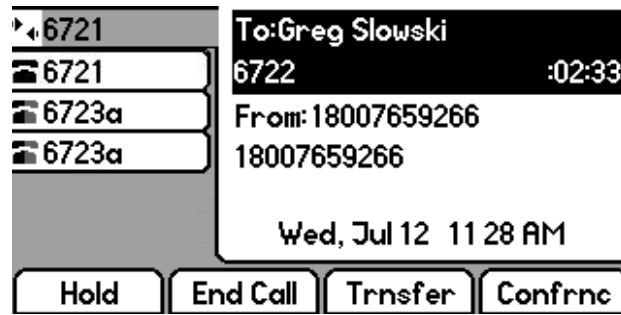

The second figure shows an incoming call from 1-800-765-9266.



To answer an incoming call when configured for multiple call appearances:

>> Do one of the following steps:

- Press  or the **Hold** soft key to put the original call on hold.
- Press  to access the new call.

Soft key labels are updated on the display with **Answer**, **Reject**, and **Forward**.

Answer the incoming call.

This places the original call on hold and refreshes the soft key labels as indicated in the following figure.



If more than two call appearances are in use, two will appear on the display and the total number will be indicated by a counter at the bottom right corner of the display. For example “2/3” indicates that the highlighted call is the second one out of a total of three.

You can also place another outbound call on the same first line. Press  during the first call and press the **NewCall** soft key to obtain dial tone for a second call.

Using Text Messaging

You can send and receive text messages using your phone. SIP Instant (Text) Messaging is supported in real-time. Received messages will be indicated by a flashing Message Waiting Indicator LED on the front of the phone and optionally a visual notification on the graphic display.

To read text messages:

1. Do one of the following steps:

– Press  .



Select *Instant Messages*.

Note

Screen options may vary with your application. Voice Mail may be accessible with a single key press. Contact your system administrator about this option.

- Press  .

Select *Features > Messages > Instant Messages*.

- Press the **InstMsg** soft key to read a message just received.
2. (Optional) If multiple lines are configured on your phone, select from which line messages are to be retrieved from the list using  and  .
Messages appear first to last in sent order.
 3. Press the **Next** or **Prev** soft keys to cycle through messages in order.
 4. Press the **More** soft key to access the **Delete**, **Reply**, and **New** soft keys.
 5. Press  or the **Exit** soft key repeatedly to return to the idle display.

To send a text message:

1. Do one of the following steps:

- Press  .



Select *Instant Messages*.

Note

Screen options may vary with your application. Voice Mail may be accessible with a single key press. Contact your system administrator about this option.

- Press  .

Select *Features > Messages > Instant Messages*.

2. (Optional) If multiple lines are configured on your phone, first select from which line to send the message from the list using  and  .
3. Press the **New** soft key.
4. Enter the desired number.

Use the **1/A/a** soft key to alternate between numeric and upper/lower case alphanumeric modes.

Note

You can also enter the SIP URL or IP address. For more information on dialing with SIP URL or IP address, refer to [To place a call using the handset:](#) on page 3-3

5. Press the **Ok** soft key.
6. Do one of the following steps:
 - Press the **Select** soft key to choose from various pre-scripted short messages.
 - Press the **Edit** soft key to compose a custom message.

Use dial pad keys to cycle through the character set. Use keys 1, *, 0, and # to select special characters.

7. Press the **Send** soft key when finished.
8. Press  or the **Exit** soft key repeatedly to return to the idle display.

Using Buddy Lists

Your SoundPoint IP 650 phone combines interactive message services and status monitoring to complement a traditional messaging application such as e-mail.

Live interaction within a pool of phones is possible by monitoring the “presence” of the parties involved. Your phone can “watch” the status of up to 8 other phones or 48 buddies. These other phones form your “buddy list”. The status of your buddies is displayed and updated in real time. Your phone can be “watched” by up to 8 other phones.

If your SoundPoint IP 650 SIP phone is configured to work with Microsoft Live Communications Server 2005, the behavior of the presence setting and buddy lists is different. For more information, contact your system administrator.

Presence

To view and change your presence settings:

1. Do one of the following steps:

- a Press  .

Select *Features > Presence*.

Select *My Status*.

- b Press the **MyStat** soft key.

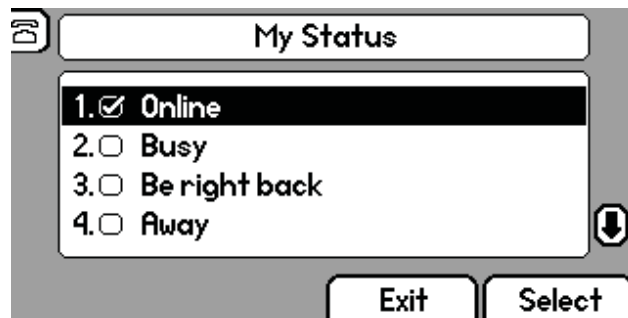

2. Use \triangle or ∇ to scroll through the list, and then press the **Select** soft key to select your new status.

This affects information sent to phones watching you.

Presence information will also be sent to watching phones when you go off-hook or enable Do Not Disturb.

Managing Buddies







Note

The instructions in this section do not apply if your call server is Microsoft Live Communications Server 2005. In that case, refer to the following section, [Integrating With Microsoft Live Communications Server 2005](#).

To add or delete a contact from your buddy list:

1. Press **Directories**.
2. Select **Contact Directory**.
3. Use \triangle and ∇ to scroll through the list to find the contact.
You can also use the * key to Page Up and the # key to Page Down.
4. Press the **Edit** soft key and scroll down to the *Watch Buddy* fields.
5. Use \triangleleft and \triangleright to select Enabled.
When *Watch Buddy* is enabled, the contact is added to your buddy list.
When *Watch Buddy* is disabled, the contact is removed from your buddy list.
The default for *Watch Buddy* is Disabled.
6. Press the **Save** or **Cancel** soft keys to accept or cancel changes.
7. Press **Directories** or the **Exit** soft key repeatedly to return to the idle display.

To block or unblock a contact from your buddy list:

1. Press .
2. Select *Contact Directory*.
3. Use  and  to scroll through the list to find the contact.
You can also use the * key to Page Up and the # key to Page Down.
4. Press the **Edit** soft key and scroll down to the *Block Buddy* fields.
5. Use  and  to select Enabled.
When *Block Buddy* is enabled, the contact cannot watch your phone. When *Block Buddy* is disabled, the contact can watch your phone.
The default for *Block Buddy* is Disabled.
6. Press the **Save** or **Cancel** soft keys to accept or cancel changes.
7. Press  or the **Exit** soft key repeatedly to return to the idle display.

Integrating With Microsoft Live Communications Server 2005

Your phone can be configured to work with Microsoft Live Communications Server 2005 and communicate with others using Microsoft Office Communicator and Windows Messenger. From your phone, you can invite, join, control, and monitor integrated multipoint audio and video conferences.

Any contacts added through your buddy list will appear as a contact in Microsoft Office Communicator and Windows Messenger. Any contacts added as a contact in Microsoft Office Communicator and Windows Messenger will appear in your buddy list.





To view and change your presence, refer to [To view and change your presence settings](#): on page 4-5.

For more information, contact your system administrator.

To add a contact to your buddy list:

1. Press , then select *Features > Presence > Buddy Status*.
2. Press the **More** soft key.
3. Press the **Add** soft key.
4. Enter the number of the contact.
5. Press the **Submit** soft key.
6. Press the **Exit** soft key repeatedly to return to the idle display.

To view and change your privacy list:

1. Press .
2. Select *Features > Presence > Buddy Status > Privacy List*.
3. Use  and  to scroll through the list to find the contact.
4. Press the **Edit** soft key.
5. For *Access*, use  and  to select Enabled.

When *Access* is enabled, you are allowing the contact to see your presence. When *Access* is disabled, you are disallowing the contact from seeing your presence.

The default for access is Disabled.

6. Press  or the **Exit** soft key repeatedly to return to the idle display.

For more information on contacting buddies, refer to [Placing a Call](#) on page 3-2 or the Microsoft Office Communicator and Windows Messenger documentation.

Restarting Your Phone

Periodically, you may need to restart your phone. The reasons for this include:

- Accepting a new configuration
- Accepting new software

Note



In the case of problems, it may be possible to restore normal operation of your phone without restarting. Contact your system administrator before attempting to restart your phone.

Note

The call lists are automatically cleared when you restart the phone.

To restart the phone:

>> Do one of the following steps:

- Simultaneously press and hold **Messages** ,  , and  for more than 3 seconds or until a beep is heard.

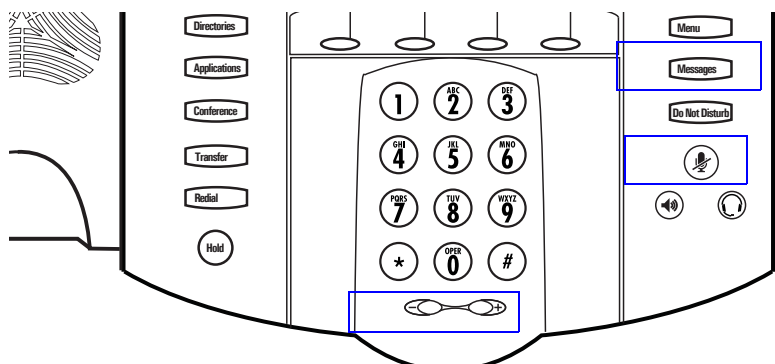

- Press **Menu** , then select *Settings > Advanced > Restart Phone*.

You must enter your password to access this menu.

The restart process will begin and is complete when the idle display is shown.

Using the SoundPoint IP Backlit Expansion Module

This chapter provides basic installation and operating instructions and information for obtaining the best performance with the SoundPoint IP Backlit Expansion Module.

The SoundPoint IP Backlit Expansion Module enhances the user interface of the SoundPoint IP 650 phone with a high-resolution graphic display and 14 Line Keys that can be automatically configured as a line, call appearance, speed dial, or busy lamp field. Up to three SoundPoint IP Backlit Expansion Modules can be connected to the SoundPoint IP 650 phone to provide a productivity-enhancing solution for users who manage and monitor multiple simultaneous telephone calls on a daily basis.

This chapter contains:

- [Parts List](#)
- [Connecting the SoundPoint IP Backlit Expansion Module](#)
- [Features of the SoundPoint IP Backlit Expansion Module](#)

This chapter contains instructions on:

- [Adjusting the Display Contrast](#)
- [Adjusting the Backlight](#)
- [Placing a Call](#)
- [Answering a Call](#)
- [Assigning Speed Dial Keys](#)
- [Using the Busy Lamp Field](#)

To customize your phone, refer to [Customizing Your SoundPoint IP 650 SIP Phone](#) on page 2-1. To read about the phone's basic features, refer to [Using the Basic Features of Your SoundPoint IP 650 SIP Phone](#) on page 3-1. To read about the phone's advanced features, refer to [Using the Advanced Features of Your SoundPoint IP 650 SIP Phone](#) on page 4-1.

If you require additional information or assistance with the Backlit Expansion Module, contact your system administrator.

Parts List

The following components are included in your SoundPoint IP Backlit Expansion Module package:

- Polycom SoundPoint IP Backlit Expansion Module

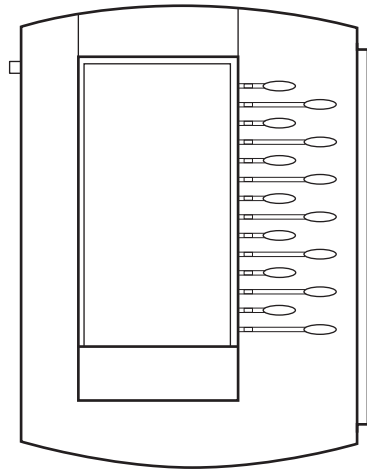

- Base stand

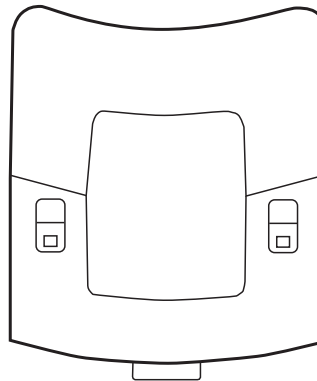

Check this list before installation to ensure that you have received each item. If you are missing any items, contact your system administrator.

Connecting the SoundPoint IP Backlit Expansion Module

This section describes how to attach the SoundPoint IP Backlit Expansion Module to your SoundPoint IP 650 phone. You can attach up to three SoundPoint IP Backlit Expansion Modules.

To connect a SoundPoint IP Backlit Expansion Module to your phone:

1. Remove the rubber plug from the SoundPoint IP 650 or the SoundPoint IP Backlit Expansion Module.

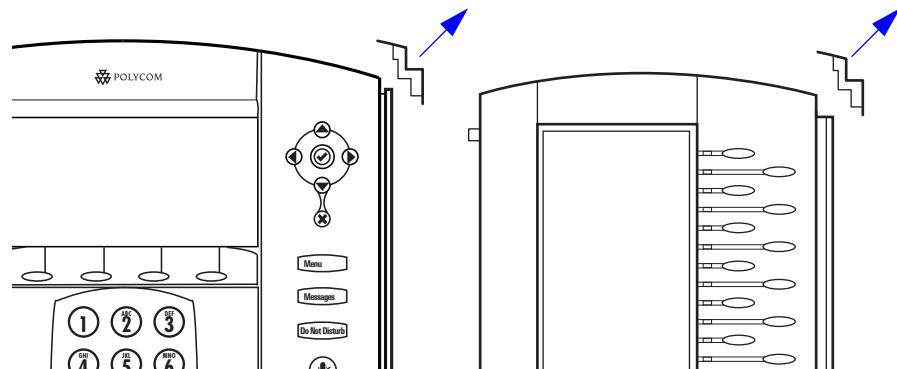

2. Align the SoundPoint IP Backlit Expansion Module at the top of the groove lines on the SoundPoint IP 650 phone and slide it downwards until it clicks into position.

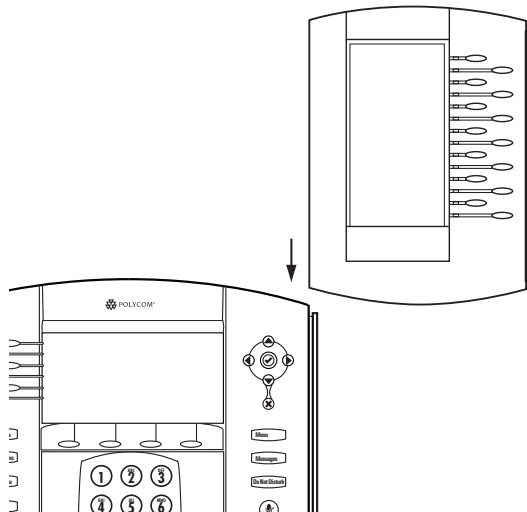

3. Connect the base stand by aligning the two protrusions on the stand to the holes on the back of the Backlit Expansion Module and snap it into place.

For each SoundPoint IP Backlit Expansion Module that you want to add, repeat steps 1 to 3.

Features of the SoundPoint IP Backlit Expansion Module

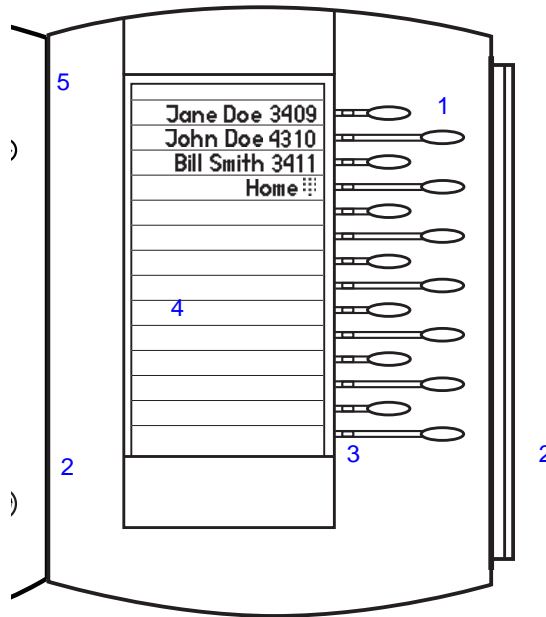

The features of the SoundPoint IP Backlit Expansion Module are:

- 1. Line/Speed Dial Key** – Use these keys to activate up to 47 lines or speed dials that can be assigned to your phone.¹
- 2. Infrared Lens** – Communications to the host phone and other Expansion Modules.
- 3. Line Indicators** – Individual multi-color LEDs display the dynamic call state and remote user status (busy lamp field (BLF) and presence). The mapping is:
 - Solid green – An active call is in progress.
 - Fast flashing green – There is an Incoming (ringing) call.
 - Flashing green – The call is held by the other party.
 - Flashing red – The call is on hold.
 - Solid red – The line is busy remotely (shared lines).
- 4. Graphic Display** – Shows information about lines or speed dials.
- 5. Power Contact** – Not visible when connected. Power is automatically transferred from the host SoundPoint IP 650 phone to the SoundPoint IP Backlit Expansion Module(s) upon connection. Units may be plugged in and unplugged at any time.

Adjusting the Display Contrast

You can adjust the display contrast on a SoundPoint IP Backlit Expansion

Module through use of the  key on the SoundPoint IP 650. For more information, refer to [Display Contrast](#) on page 2-3.

Adjusting the Backlight

You can adjust the backlight on a SoundPoint IP Backlit Expansion Module

through use of the  key on the SoundPoint IP 650. For more information, refer to [Backlight Intensity](#) on page 2-4.

Placing a Call

When a SoundPoint IP Backlit Expansion Module is connected to your SoundPoint IP 650 phone, you can place a call using one of the Line Keys.

To place a call using a SoundPoint IP Backlit Expansion Module Line Key:

>> Press the assigned  directly opposite the number on the graphic display.

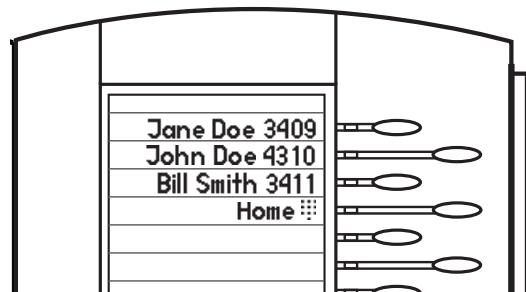

For more information on placing a call, refer to [Placing a Call](#) on page 3-2.

Answering a Call

When a SoundPoint IP Backlit Expansion Module is connected to your SoundPoint IP 650 phone, you can answer a call using one of the Line Keys.

To answer a call using a SoundPoint IP Backlit Expansion Module Line Key:

>> Press the assigned  directly opposite the line with the fast flashing green LED indicator.

For more information on answering a call, refer to [Answering a Call](#) on page 3-4.

Assigning Speed Dial Keys

You can associate contacts with Line Keys on the SoundPoint IP Backlit Expansion Module for single touch dialing of frequently used numbers. Speed Dial entries are consecutively placed next to assigned Line Keys.

For example in the figure below, press the fourth **Line Key** to dial home.

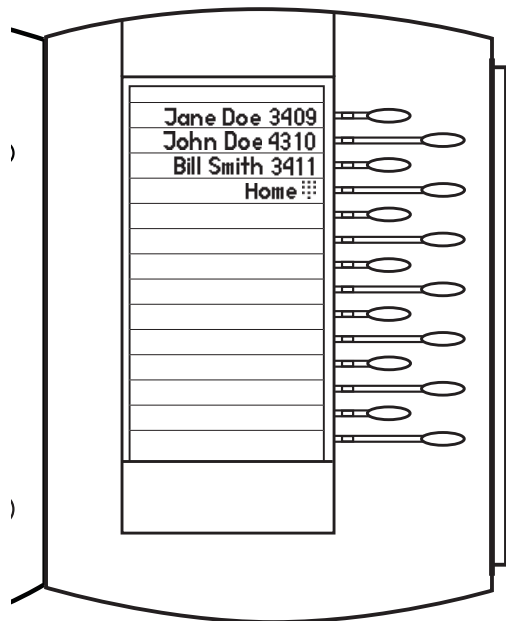

To assign a new speed dial key:

1. Press and hold an unassigned .
2. Press the **More** soft key.

3. Press the **Add** soft key.
4. Enter first and/or last name of the contact from the keypad.
Use the **1/A/a** soft key to select between numeric and upper/lower case alphanumeric modes.
Use the **Encoding** soft key to access special characters in other languages.
5. Enter a contact number.
This is a required field and it must be unique (not already in the directory).
6. Change the *Speed Dial Index*.
The index can be any value between the next available index value and the maximum (9999).



Polycom recommends that you assign speed dial index values consecutively. For example, if the third Line Key is assigned to the speed dial index value "2", assign the fourth Line Key the speed dial index value "3".

7. Press the **Save** or **Cancel** soft keys to accept or cancel changes.
8. Press  or the **Exit** soft key repeatedly to return to the idle display.

For more information on assigning speed dial keys, refer to [Assigning Speed Dial Keys](#) on page 3-18.

Using the Busy Lamp Field

The busy lamp field (BLF) feature allows you to monitor the hook status and remote party information of other users through the BLF LED indicators and display on the SoundPoint IP 650 phone with the attached Backlit Expansion Module. For more information, contact your system administrator.

The following figure shows the busy status of other users (for example, Jim Brown and Rob Smith are busy on the phone):

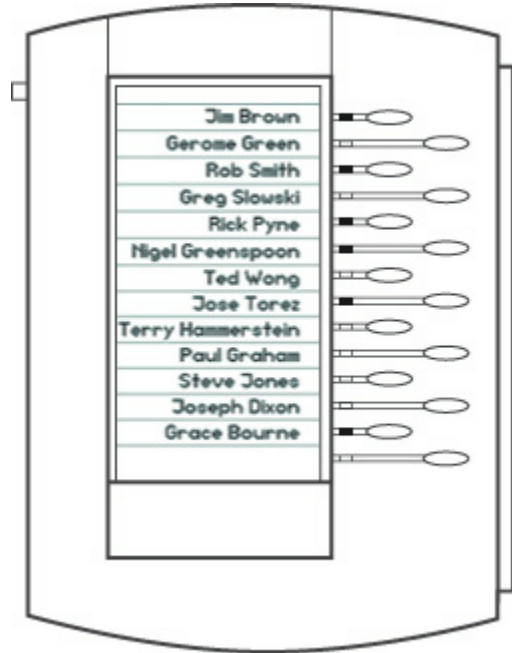

Troubleshooting Your SoundPoint IP 650 SIP Phone

This chapter presents problems, likely causes, and corrective actions. Problems are grouped as follows:

- [Power and Startup](#)
- [Controls](#)
- [Access to Screens and Systems](#)
- [Calling](#)
- [Displays](#)
- [Audio](#)

If you still need assistance, contact your system administrator.

Power and Startup

Symptom	Problem	Corrective Action
There are power issues.	The SoundPoint IP 650 phone has no power.	Do one of the following steps: <ul style="list-style-type: none"><li data-bbox="971 449 1414 506">• Verify that no lights appear on the unit when it is powered up.<li data-bbox="971 516 1414 573">• Check if the phone is properly plugged into a functional AC outlet.<li data-bbox="971 583 1414 674">• Make sure that the phone isn't plugged into a plug controlled by a light switch that is off.<li data-bbox="971 684 1414 774">• If plugged into a power strip, try plugging directly into a wall outlet instead.<li data-bbox="971 785 1414 863">• Try the phone in another room where the electricity is known to be working on a particular outlet.

Controls

Symptom	Problem	Corrective Action
<p>The dial pad does not work.</p>	<p>The dial pad on the SoundPoint IP 650 phone does not respond.</p>	<p>Do one of the following steps:</p> <ul style="list-style-type: none"> • Check for a response from other feature keys or from the dialpad. • Place a call to the phone from a known working telephone. Check for display updates. • Press the Menu key followed by System Status and Server Status to check if the telephone is registered correctly to the server. • Press the Menu key followed by System Status and Network Statistics. Scroll down to see if LAN port shows active or Inactive. • Check the termination at the switch or hub end of the network LAN cable. Ensure that the switch/hub port connected to the telephone is operational (if not accessible, contact your system administrator). • Before restarting your phone, contact your system administrator, since this may allow more detailed troubleshooting to occur before losing any current status information.

Access to Screens and Systems

Symptom	Problem	Corrective Action
There is no response from feature key presses.	The SoundPoint IP 650 phone is not in active state.	<p>Do one of the following steps:</p> <ul style="list-style-type: none"> • Press the keys more slowly. • Check with the system administrator to see whether or not the key has been mapped to a different function or disabled. • Make a call to the phone to check for inbound call display and ringing as normal. If successful, try to press feature keys within the call to access the Menu, for example. • Press Menu followed by Status > Lines to confirm line is actively to the call server. • Reboot the phone to attempt re-registration to the call server (refer to Restarting Your Phone on page 4-8).
The display shows “Network Link is Down”.	The LAN cable is not properly connected.	<p>Do one of the following steps:</p> <ul style="list-style-type: none"> • Check termination at the switch or hub (furthest end of the cable from the phone). • Check that the switch or hub is operational (flashing link/status lights) or contact your system administrator. • Press Menu followed by Status > Network. Scroll down to verify that the LAN is active. • Reboot the phone to attempt re-registration to the call server (refer to Restarting Your Phone on page 4-8).

Calling

Symptom	Problem	Corrective Action
There is no dial tone.	Power is not correctly applied to the SoundPoint IP 650 phone.	<p>Do one of the following steps:</p> <ul style="list-style-type: none"> • Check that the display is illuminated. • Make sure the LAN cable is inserted properly at the rear of the phone (try unplugging and re-inserting the cable). • If using PoE, have your system administrator check that the switch is supplying power to the phone.
	Dial tone is not present on one of audio paths.	<p>Do one of the following steps:</p> <ul style="list-style-type: none"> • Switch between Handset, Headset (if present) or Hands-Free Speakerphone to see if dial tone is present on other paths. • If dial tone exists on another path, connect a different handset or headset to isolate the problem.

Symptom	Problem	Corrective Action
The phone does not ring.	Ring setting or volume is low.	Do one of the following steps: <ul style="list-style-type: none"> • Adjust the ringing level from the front panel using the volume up/down keys. • Check same status of handset, headset (if connected) and through the Hands-Free Speakerphone.
	Outbound or inbound calling is unsuccessful.	Do one of the following steps: <ul style="list-style-type: none"> • Place a call to the phone under investigation. Check that the display indicates incoming call information. • Lift the handset. Ensure dial tone is present and place a call to another extension or number. Check that the display changes in response.
	You turned off the ringer.	Do one of the following steps: <ul style="list-style-type: none"> • When there is an incoming call, lift the handset, press Speakerphone key or press Headset key and you will get a dialtone. • Pressing the ringing Line Key or Answer soft key will answer the call. • If the handset is off-hook when Answer soft key or Line Key is pressed, the call is routed to the handset. • If the handset is on-hook when Answer soft key or Line Key is pressed, the call is routed to the speaker.
"Service Unavailable" is displayed on the graphic display.	The user pressed the New Call soft key, dialed a number with the handset on-hook, attempted to make a call from the contact directory when the phone was not registered.	Do one of the following steps: <ul style="list-style-type: none"> • Check with the system administrator to see when your phone will be registered.

Displays

Symptom	Problem	Corrective Action
<p>There is no display. The display is incorrect. The display has bad contrast.</p>	<p>Power is not correctly applied to the SoundPoint IP 650 phone.</p>	<p>Do one of the following steps:</p> <ul style="list-style-type: none"> • Check that the display is illuminated. • Make sure the LAN cable is inserted properly at the side of the phone (try unplugging and re-inserting the cable). • If using in-line powering, have your system administrator check that the switch is supplying power to the phone.
	<p>The contrast needs adjustment.</p>	<p>Do one of the following steps:</p> <ul style="list-style-type: none"> • Refer to Display Contrast on page 2-3. • Reboot the phone to obtain a default level of contrast (refer to Restarting Your Phone on page 4-8).
	<p>Outbound or inbound calling is unsuccessful.</p>	<p>Do one of the following steps:</p> <ul style="list-style-type: none"> • Place a call to the phone under investigation. Check that the display indicates incoming call information. • Lift the handset. Ensure dial tone is present and place a call to another extension or number. Check that the display changes in response.
<p>The display is flickering.</p>	<p>Certain type of older fluorescent lighting causes the display to appear to flicker.</p>	<p>Do one of the following steps:</p> <ul style="list-style-type: none"> • Move the SoundPoint IP 650 SIP phone away from the lights. • Replace the lights.

Audio

Symptom	Problem	Corrective Action
<p>There is no audio on the headset.</p>	<p>The connections are not correct.</p>	<p>Do one of the following steps:</p> <ul style="list-style-type: none"> • Ensure the headset is plugged into the jack marked Headset at the rear of the phone. • Ensure the headset amplifier (if present) is turned on and/or the volume is correctly adjusted).

Regulatory Notices

Service Agreements

Please contact your Polycom Authorized Reseller for information about service agreements applicable to your product.

Governing Law

This Limited Warranty and Limitation of Liability shall be governed by the laws of the State of California, U.S.A., and by the laws of the United States, excluding their conflicts of laws principles. The United Nations Convention on Contracts for the International Sale of Goods is hereby excluded in its entirety from application to this Limited Warranty and Limitation of Liability.

All rights reserved under International and Pan-American Copyright Conventions. No part of the contents of this manual may be copied, reproduced, or transmitted in any form or by any means, or translated into another language or format, in whole or part, without written consent from Polycom, Inc. Do not remove (or allow anybody else to remove) any product identification, copyright or other notices.

Limitations of Liability

LIMITATION OF LIABILITY. TO THE FULL EXTENT ALLOWED BY LAW, POLYCOM EXCLUDES FOR ITSELF AND ITS SUPPLIERS ANY LIABILITY, WHETHER BASED IN CONTRACT OR TORT (INCLUDING NEGLIGENCE), FOR INCIDENTAL, CONSEQUENTIAL, INDIRECT, SPECIAL, OR PUNITIVE DAMAGES OF ANY KIND, OR FOR LOSS OF REVENUE OR PROFITS, LOSS OF BUSINESS, LOSS OF INFORMATION OR DATA, OR OTHER FINANCIAL LOSS ARISING OUT OF OR IN CONNECTION WITH THE SALE, INSTALLATION, MAINTENANCE, USE, PERFORMANCE, FAILURE, OR INTERRUPTION OF ITS PRODUCTS, EVEN IF POLYCOM OR ITS AUTHORIZED RESELLER HAS BEEN ADVISED OF THE POSSIBILITY OF SUCH DAMAGES, AND LIMITS ITS LIABILITY TO REPAIR, REPLACEMENT, OR REFUND OF THE PURCHASE PRICE PAID, AT POLYCOM'S OPTION. THIS DISCLAIMER OF LIABILITY FOR DAMAGES WILL NOT BE AFFECTED IF ANY REMEDY PROVIDED HEREIN SHALL FAIL OF ITS ESSENTIAL PURPOSE.

Polycom Limited Warranty and Limitation Liability

LIMITED WARRANTY. Polycom warrants to the end user (“Customer”) that this product is expected to be free from defects in workmanship and materials, under normal use and service, for one year from the date of purchase from Polycom or its authorized reseller.

Polycom’s sole obligation under this express warranty is at Polycom’s option and expense, to repair the defective product or part, deliver to Customer an equivalent product or part to replace the defective item, or if neither of the two foregoing options are reasonably available, Polycom may, on its sole discretion, refund to Customer the purchase price paid for the defective product. All products that are replaced will become the property of Polycom. Replacement products or parts may be new or reconditioned.

Polycom is expected to warrant any replaced or repaired product or part for ninety (90) days from shipment, or the remainder of the initial warranty period, whichever is longer. Products returned to Polycom must be sent prepaid and packaged appropriately for safe shipment, and it is recommended that they be insured or sent by a method that provides for tracking of the package. Responsibility for loss or damage does not transfer to Polycom until the returned item is received by Polycom. The repaired or replaced item will be shipped to Customer, at Polycom’s expense, not later than thirty (30) days after Polycom receives the defective product, and Polycom will retain risk of loss or damage until the item is delivered to Customer.

The product software comes with 90-day software warranty, providing for software updates (minor releases/bug fixes). To continue to receive support, purchasing a maintenance contract is the most economical solution.

Exclusions

Polycom will not be liable under this limited warranty if its testing and examination disclose that the alleged defect or malfunction in the product does not exist or results from:

- Failure to follow Polycom’s installation, operation, or maintenance instructions.
- Unauthorized product modification or alteration.
- Unauthorized use of common carrier communication services accessed through the product.
- Abuse, misuse, negligent acts or omissions of Customer and persons under Customer’s control; or
- Acts of third parties, acts of God, accident, fire, lightening, power surges or outages, or other hazards.

Warranty Exclusive

IF A POLYCOM PRODUCT DOES NOT OPERATE AS WARRANTED ABOVE, CUSTOMER’S SOLE REMEDY FOR BREACH OF THAT WARRANTY SHALL BE REPAIR, REPLACEMENT, OR REFUND OF THE PURCHASE PRICE PAID, AT POLYCOM’S OPTION. TO THE FULL EXTENT ALLOWED BY LAW, THE FOREGOING WARRANTIES AND REMEDIES ARE EXCLUSIVE AND ARE IN LIEU OF ALL OTHER WARRANTIES, TERMS, OR CONDITIONS, EXPRESS OR IMPLIED, EITHER IN FACT OR BY OPERATION OF LAW, STATUTORY OR OTHERWISE, INCLUDING WARRANTIES, TERMS, OR CONDITIONS OF MERCHANTABILITY, FITNESS FOR A PARTICULAR PURPOSE, SATISFACTORY QUALITY, CORRESPONDENCE WITH DESCRIPTION, AND NON-INFRINGEMENT, ALL OF WHICH ARE EXPRESSLY DISCLAIMED. POLYCOM NEITHER ASSUMES NOR AUTHORIZES ANY OTHER PERSON TO ASSUME FOR IT ANY OTHER LIABILITY IN CONNECTION WITH THE SALE, INSTALLATION, MAINTENANCE OR USE OF ITS PRODUCTS.

Safety and Compliance

Part 15 FCC Rules

This device is compliant with Part 15 of the FCC Rules. Operation is subject to the following two conditions:

1. This device may not cause harmful interference, and
2. This device must accept any interferences received, including interference that may cause undesired operation.

Class B Digital Device or Peripheral

Note: This equipment is tested and complies with the limits for a Class B digital device, pursuant to Part 15 of the FCC Rules. These limits are designed to provide reasonable protection against harmful interference in a residential installation. This equipment generates, uses, and can radiate radio frequency energy and, if not installed and used in accordance with the instructions, may cause harmful interference to radio communications. However, there is no guarantee that interference will not occur in a particular installation. If this equipment does cause harmful interference to radio or television reception, which can be determined by turning the equipment off and on, the user is encouraged to try to correct the interference by one or more of the following measures:

1. Reorient or relocate the receiving antenna.
2. Increase the separation between the equipment and receiver.
3. Connect the equipment into an outlet on a circuit different from that to which the receiver is connected.
4. Consult the dealer or an experience radio/TV technician for help.

Modifications

In accordance with Part 15 of the FCC Rules, the user is cautioned that any changes or modifications not expressly approved by Polycom, Inc. could void the user's authority to operate the equipment. This equipment may not be used on a coin service or party line.

Installation Instructions

Installation must be performed in accordance with all relevant national wiring rules.

L'Installation doit être exécutée conformément à tous les règlements nationaux applicable au filage électrique.

Plugs Acts as Disconnect Device

The socket outlet to which this apparatus is connected must be installed near the equipment and must always be readily accessible.

La prise électrique à laquelle l'appareil est branché doit être installée près de l'équipement et doit toujours être facilement accessible.

Industry Canada (IC)

This Class [B] digital apparatus complies with Canadian ICES-003.

Cet appareil numérique de la classe [B] est conforme à la norme NMB-003 du Canada.

CE and VCCI Mark

This SoundPoint IP 500/501 SIP is marked with the CE mark. This mark indicates compliance with EEC directories 89/336/EEC and 73/23/EEC. A full copy of the Declaration of Conformity can be obtained from Polycom Ltd., 270 Bath Road, Slough, Berkshire, SL1 4DX, UK.

この装置は、情報処理装置等電波障害自主規制協議会（VCCI）の基準に基づくクラスB情報技術装置です。この装置は、家庭環境で使用することを目的としていますが、この装置がラジオやテレビジョン受信機に近接して使用されると、受信障害を引き起こすことがあります。

取扱説明書に従って正しい取り扱いをして下さい。

Index

Symbols

key, page down shortcut 1-12

* key, page up shortcut 1-12

A

AC power 1-4

answering calls 3-4, 3-5

assembling your phone 1-3

assigning speed dial keys 3-18

B

backlight intensity 2-4

Backlit Expansion Module. *See* SoundPoint IP
Backlit Expansion Module

base, attaching 1-6

block buddies 4-7

buddy lists 4-5

buddy status 4-8

C

call lists

missed calls 2-9

placed calls 2-9

received calls 2-9

types of 2-9

calls

ending 3-8

on hold 3-9

contact directory 2-10

contact lists. *See* buddy lists

customizing your phone 2-1

D

display contrast 2-3

Do Not Disturb 3-17

down arrow key, Missed Calls shortcut 2-10

E

ending calls 3-8

F

features

advanced 4-1

basic 3-1

list of 1-9

SoundPoint IP 650 1-9

SoundPoint IP Backlit Expansion Module 5-1

forwarding calls 3-14

G

getting started with your phone 1-1

H

handset

answering a call 3-5

connecting 1-5

illustration 1-2

placing a call 3-3

hands-free mode

answering a call 3-5

placing a call 3-3

headset

answering a call 3-6

connecting 1-5

memory mode 2-6

placing a call 3-4

headset memory mode 2-6

holding calls 3-9

I

instant messaging 4-3

L

language support 2-8

left arrow key, Received Calls shortcut 2-10

M

managing buddies 4-6

Microsoft Office Live Communications
Server 2005 4-5, 4-7

- missed call lists 2-9
- multiple call appearances 4-1
- multiple calls, hold 3-10
- multiple keys per line 2-18
- multiple lines
 - call forwarding 3-15
 - Do Not Disturb 3-18
 - ring type 2-7
 - support for 2-17
 - text messaging 4-4
 - Voice Mail 3-20
- muting microphone 2-8
- MyStat 4-5

N

- navigation key usage 1-12
- network connection, phone 1-3

P

- parts list 1-2
- placed call lists 2-9
- placing calls 3-2
- PoE. *See* Power over Ethernet
- power adapter, connecting 1-4
- Power over Ethernet (PoE) 1-4
- power source, phone 1-3
- presence 4-5

R

- received call lists 2-9
- redialing numbers 3-8
- restarting phone 4-8
- right arrow key, Placed Calls shortcut 2-10
- ring type 2-7
- RJ-9 1-6

S

- setting up conferences 3-10
- shared lines 2-19
- silent ring, answering calls 3-5
- SoundPoint IP 650
 - adjusting backlight intensity 2-4
 - adjusting display contrast 2-3
 - adjusting volume 2-9
 - advanced features 4-1
 - answering calls 3-4, 3-5
 - assembling 1-3
 - assigning speed dial keys 3-18

- attaching base 1-6
- Backlit Expansion Module 5-1
- basic features 3-1
- buddy lists 4-5
- call lists, types of 2-9
- calls, on hold 3-9
- contact directory 2-10
- customizing 2-1
- Do Not Disturb 3-17
- ending calls 3-8
- features, list of 1-9
- figure, features 1-9
- forwarding calls 3-14
- getting started 1-1
- handset 1-5
- headset 1-5
- headset memory mode 2-6
- illustration 1-2
- instant messaging 4-3
- language support 2-8
- multiple call appearances 4-1
- multiple keys per line 2-18
- muting microphone 2-8
- navigation key usage 1-12
- parts list 1-2
- placing calls 3-2
- presence 4-5
- redialing numbers 3-8
- restarting phone 4-8
- ring type 2-7
- setting time and date 2-2
- setting up conferences 3-10
- shared lines 2-19
- text messaging 4-3
- transferring calls 3-12
- troubleshooting 6-1
- using multiple lines 2-17
- voice mail 3-20

- SoundPoint IP Backlit Expansion Module
 - figure, features 5-4
- speakerphone. *See* hands-free mode
- speed dialing 3-18

T

- text messaging 4-3
- time and date 2-2
- transferring calls 3-12

troubleshooting

- audio problems 6-7
- calling problems 6-5
- controls problems 6-3
- display problems 6-7
- power and startup problems 6-2
- screen and system problems 6-4

U

- up arrow key, Speed Dial Index shortcut 3-18
- using SIP URL for calling 3-3

V

- voice mail 3-20
- volume 2-9

W

- watch buddies 4-6

